



# quadro



quadro

**DESIGN**

**MEETS PERFORMANCE**

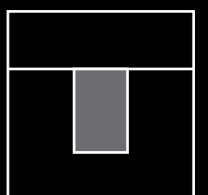

Surface

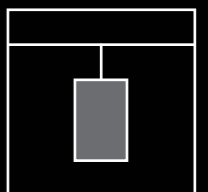

Pendant

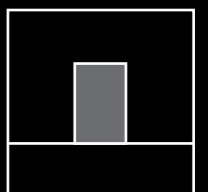

Recessed

**NEUE  
GREEN-LINIE**



**QUADRO.GREEN  
DIE PROFILLEUCHE MIT DEM REDUZIERTEN  
CO2-FUSSABDRUCK**

PLANLICHT setzt auch in Bezug auf die bei der Leuchten-Produktion eingesetzten Materialien auf Nachhaltigkeit. Die green-Linie nutzt das umweltfreundlichere „Hydro Low-Carbon Aluminium“, das einen geringeren Kohlendioxid-Fußabdruck aufweist. Durch den Einsatz von erneuerbaren Energiequellen wie Wasserkraft, Wind und Sonne in Kombination mit einer hocheffizienten Elektrolyse-technologie wird bei der Herstellung von „Hydro Low-Carbon Aluminium“ maximal 4,0 kg CO<sub>2</sub> pro kg Aluminium freigesetzt. Dies ist in etwa ein Viertel des weltweiten Durchschnitts und ein wichtiger Schritt in Richtung einer nachhaltigeren Zukunft. Nicht nur ist „Hydro Low-Carbon Aluminium“ von der DNV-GL nach ISO 14064 verifiziert, es ist auch durch eine Umwelt-Produkt-Deklaration bestätigt.

**Eine bewusste, umweltfreundlicher Materialwahl für eine nachhaltige Zukunft.**

**QUADRO.GREEN  
THE PROFILE LUMINAIRE WITH A REDUCED  
CO2 FOOTPRINT**

*PLANLICHT also focuses on sustainability when it comes to the materials used in the production of luminaires and lighting solutions. The new green product line uses more environmentally friendly "Hydro Low-Carbon Aluminium", which has a reduced carbon footprint. By using renewable energy sources such as hydropower, wind, and solar power in combination with highly efficient electrolysis technology, the production of "Hydro Low-Carbon Aluminium" emits a maximum of 4.0 kg CO<sub>2</sub> per kg of aluminium. This equals only a quarter of the global average and is an important step towards a more sustainable future. Not only is "Hydro Low-Carbon Aluminium" verified according to ISO 14064 by DNV-GL, it is also certified by an environmental product declaration.*

**A conscious, environmentally friendly material choice für a sustainable future.**

# QUADRO FEATURES



### SPEZIELLES RASTER-DESIGN

Die Louvre-Designs (BAP) sind in verschiedenen Effektfarben erhältlich. Neuer Raster: PLF

*Special louvre design  
Design à lamelles spécial*



### VERSCHIEDENE DIFFUSOREN

Die Leuchte ist auch mit opalem Diffusor oder Mikroprisma erhältlich.

*Different diffusers  
Diffuseurs différents*



### SPEZIALLEUCHE FÜR ARBEITSPLÄTZE

Beleuchtung von rechts und links, um Schatten und Reflexblendung zu vermeiden.

*Office special version  
Luminaire spécial pour les postes de travail*



### DIREKT / INDIREKTE BELEUCHTUNG

Homogene und sanfte Ausleuchtung von Räumen mit optionaler indirekter Beleuchtung.

*Direct/indirect lighting  
Éclairage direct / indirect*

### EINFACHE INSTALLATION

Die Einbauleuchte kann mühelos mit Montagehalterungen angebracht werden.

*Quick mounting  
Installation facile*



### DYNAMISCHES WEISS

Human Centric Lighting mit einstellbarem Weißlicht von 2.700 bis 6.500 Kelvin.

*Dynamic white  
Blanc dynamique*



### SPEZIELLE AKUSTIKVERSION

Die quadro.quiet bietet eine ausgezeichnete Schallabsorption.

*Special acoustic version  
Version acoustique spéciale*



### QUADRO.GREEN

Auch mit „green“-Gehäuse erhältlich (CO<sub>2</sub>-reduziert)

*quadro.green  
quadro.green*



### VERSCHIEDENE OPTIKEN

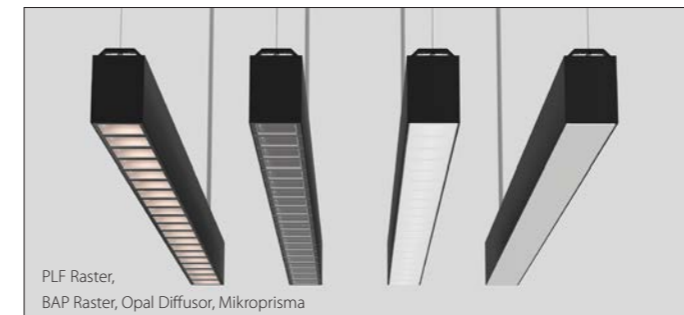

### PLF - PARABOLIC LOUVRE FLAT (BREITSTRALENDE RASTER-VARIANTE)

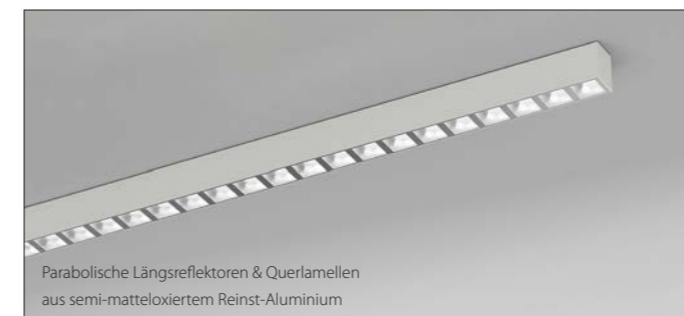

Parabolische Längsreflektoren & Querlamellen aus semi-matteloxiertem Reinst-Aluminium

### TAUSENDE FARBKOMBINATIONEN



Wählen Sie Ihre Wunschfarbe

## QUADRO - DESIGN MEETS PERFORMANCE

Inspiration



**QUADRO  
PROJEKTE**



**FAMILIENGERICHT HEILBRONN | DEUTSCHLAND**

Produkt: quadro  
Foto: © Angelo Kaunat

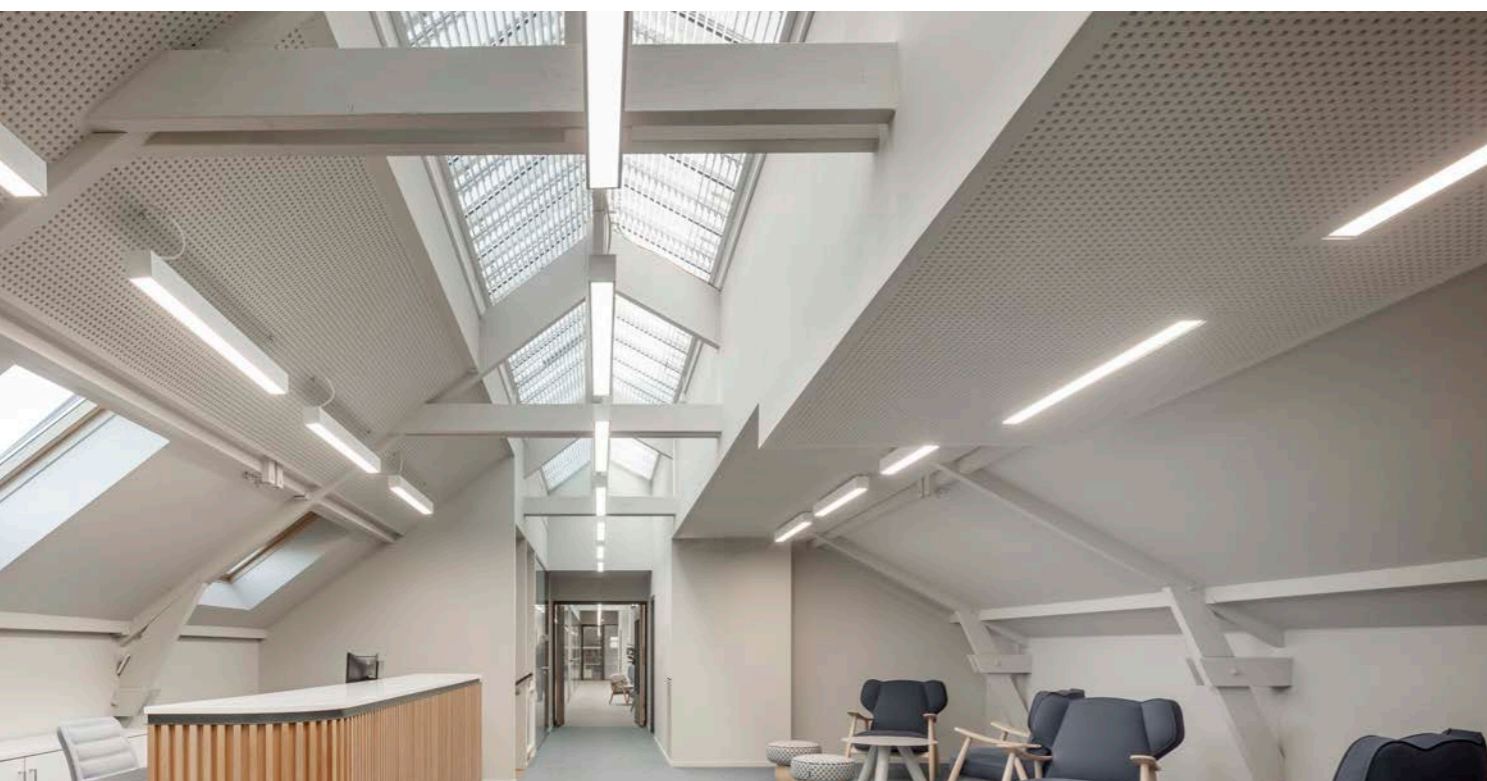

**ECOLE COMMERCE PARIS | FRANKREICH**

Produkt: quadro  
Foto: © Luc Boegly | Architekten: Pangalos Feldmann Architects & Lagranja Design



**BWF GROUP SHOWROOM | DEUTSCHLAND**

Produkt: quadro.quiet



**INSPIRATION**

Produkt: quadro



**INSPIRATION**

Produkt: quadro

# quadro

Aufbauleuchte  
Surface lumineuse  
Luminaires en saillie

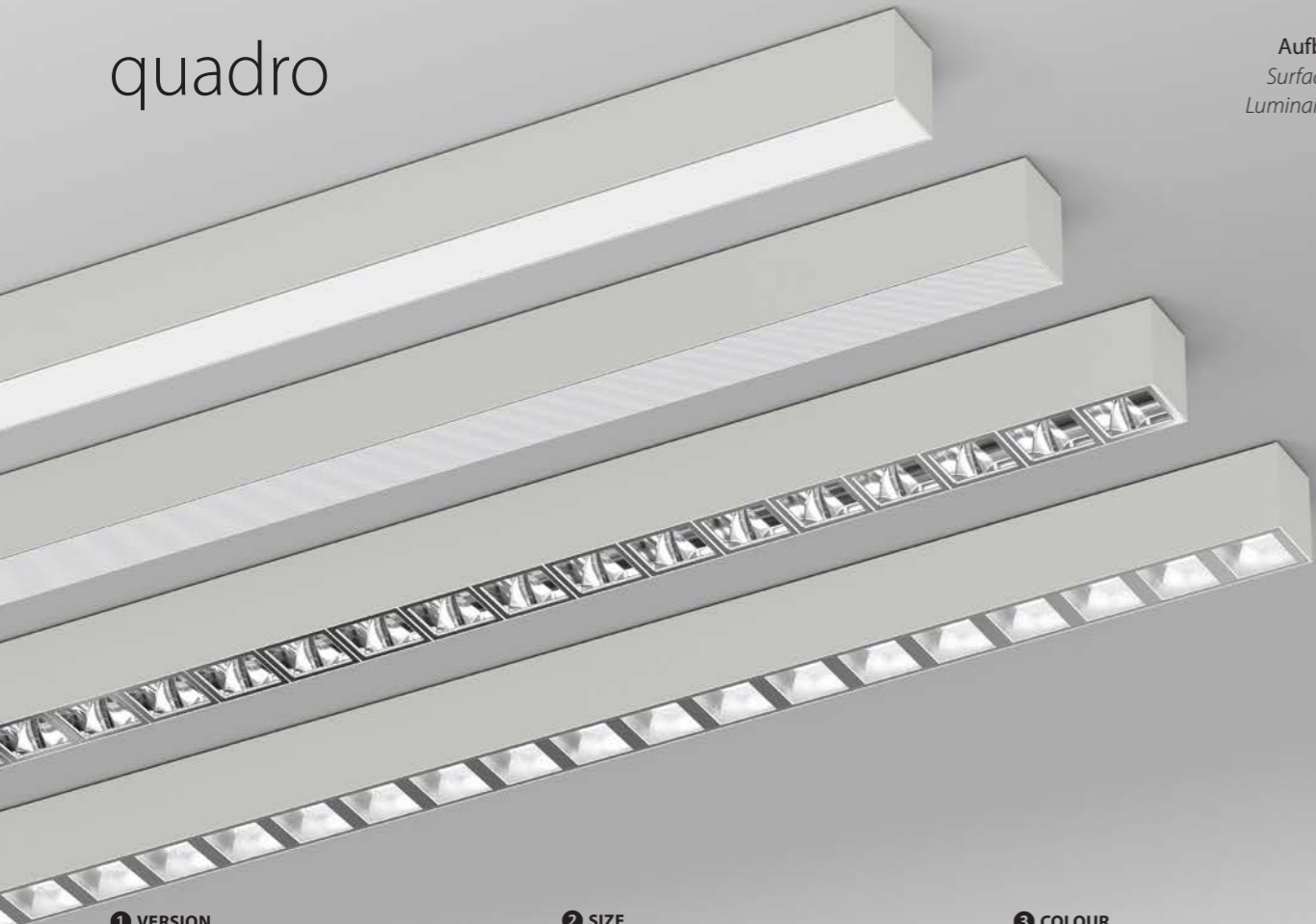

## 1 VERSION

quadro  
**NEW** quadro.green

## 2 SIZE

| Version           | Size                     | Length (mm) | Width (mm) | Weight (kg) |
|-------------------|--------------------------|-------------|------------|-------------|
| BAP               | BAP Sensor               | 1124        | 1194       | 119         |
|                   |                          | 1404        | 1474       | 147         |
|                   |                          | 1684        | 168        |             |
|                   |                          | 2244        | 224        |             |
|                   |                          | 2804        | 280        |             |
|                   |                          | 3364        | 336        |             |
| satiné/microprism | satiné/microprism Sensor | 1130        | 1200       | 120         |
|                   |                          | 1410        | 1480       | 148         |
|                   |                          | 1690        | 169        |             |
|                   |                          | 2250        | 225        |             |
|                   |                          | 2810        | 281        |             |
|                   |                          | 3370        | 337        |             |

## 3 COLOUR

|  |                    |      |
|--|--------------------|------|
|  | silver             | 9006 |
|  | white              | 9016 |
|  | black              | 9005 |
|  | RAL of your choice |      |

## 4 LED

|  |  |     |
|--|--|-----|
|  | 3000 K, CRI > 80                       | 830 |
|  | 4000 K, CRI > 80                       | 840 |
|  | 3000 K, CRI > 90                       | 930 |
|  | 4000 K, CRI > 90                       | 940 |
|  | 2700 - 6500 K, dynamic white, CRI > 90 | HCL |

## 5 OUTPUT/CONTROL

| Control | non Sensor         | with Sensor     |
|---------|--------------------|-----------------|
|         | low output non-dim | L1              |
|         | low output DALI    | L3              |
|         | high output DALI   | H3              |
|         | dynamic white      | X3              |
|         |                    | X7 (on request) |

## 6 OPTIC

|                        |   |  |   |
|------------------------|---|--|---|
| satiné                 | S | BAP white (RAL 9016)*                        | W |
| microprism*            | M | BAP black (RAL 9005)*                        | N |
| BAP high-gloss silver* | B | BAP glaring gold*                            | D |
| BAP silver matte*      | P | BAP capital copper*                          | R |
| BAP high-gloss gold*   | G | BAP gunnery grey*                            | Y |
| BAP high-gloss copper* | K | BAP high gloss black chrome*                 | Z |
|                        |   | PLF Parabolic Louvre Flat silver semi-matte* | F |

\* UGR-optimised, configure online

T6 1 A 2 - 3 C1 4 5 6

T65A112-9016C1840H3B quadro, 1124 mm, white, 4000 K, CRI > 80, high output DALI, BAP high-gloss silver (order sample)

► Configure online on [KATALOG.PLANLICHT.COM](https://www.katalog.planlicht.com)

## QUADRO | SURFACE

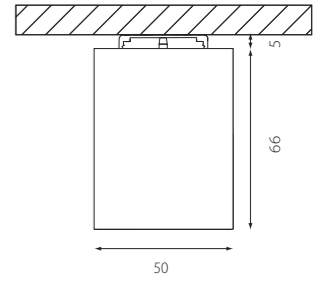
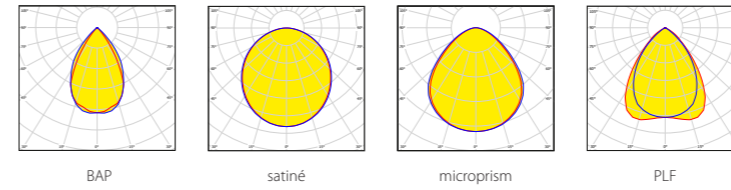

## LUMINOUS FLUX (LM) / SYSTEM POWER (W)

| Length (mm) | low output CRI > 80 | high output CRI > 80 | dynamic white CRI > 90 | Weight (kg) |
|-------------|---------------------|----------------------|------------------------|-------------|
| 1124 mm     | 2083 lm / 19W       | 4067 lm / 38W        | 3227 lm / 39W          | 3,0 kg      |
| 1404 mm     | 2603 lm / 23W       | 5083 lm / 47W        | 4033 lm / 48W          | 3,6 kg      |
| 1684 mm     | 3123 lm / 27W       | 6099 lm / 56W        | 4839 lm / 57W          | 4,5 kg      |
| 2244 mm     | 4163 lm / 37W       | 8131 lm / 73W        | 6451 lm / 74W          | 6,0 kg      |
| 2804 mm     | 5203 lm / 46W       | 10163 lm / 94W       | 8063 lm / 95W          | 7,5 kg      |
| 3364 mm     | 6244 lm / 55W       | 12195 lm / 111W      | 9674 lm / 113W         | 9,0 kg      |

(based on optic BAP, DALI) (based on optic S, DALI)

## COMPARE COVER 1404 MM

| Optic                   | low output CRI > 80 | high output CRI > 80 | dynamic white CRI > 90 |
|-------------------------|---------------------|----------------------|------------------------|
| satiné                  | 2000 lm / 16W       | 3474 lm / 30W        | 2630 lm / 29W          |
| microprism*             | 1580 lm / 16W       | 2745 lm / 30W        | 2078 lm / 29W          |
| high-gloss silver       | 3005 lm / 23W       | 5869 lm / 47W        | 4656 lm / 48W          |
| silver matte            | 2603 lm / 23W       | 5083 lm / 47W        | 4033 lm / 48W          |
| high-gloss gold         | 2748 lm / 23W       | 5367 lm / 47W        | 4258 lm / 48W          |
| high-gloss copper       | 2731 lm / 23W       | 5334 lm / 47W        | 4232 lm / 48W          |
| BAP white               | 2827 lm / 23W       | 5521 lm / 47W        | 4380 lm / 48W          |
| BAP black               | 1495 lm / 23W       | 2920 lm / 47W        | 2316 lm / 48W          |
| glaring gold            | 1749 lm / 23W       | 3416 lm / 47W        | 2710 lm / 48W          |
| capital copper          | 1589 lm / 23W       | 3104 lm / 47W        | 2463 lm / 48W          |
| gunnery grey            | 1767 lm / 23W       | 3451 lm / 47W        | 2738 lm / 48W          |
| high gloss black chrome | 1767 lm / 23W       | 3451 lm / 47W        | 2738 lm / 48W          |
| parabolic louvre flat   | 3457 lm / 29W       | 5319 lm / 47W        | 4220 lm / 48W          |

## COMPARE LIGHT COLOUR 1414 MM BAP SILVER MATTE

|                  |         |       |
|------------------|---------|-------|
| 4000 K, CRI > 80 | 5083 lm | +4,5% |
| 4000 K, CRI > 90 | 5313 lm |       |
| 3000 K, CRI > 80 | 4850 lm | +4,5% |
| 3000 K, CRI > 90 | 5068 lm |       |

## 6 BAP LOUVRE COLOURS

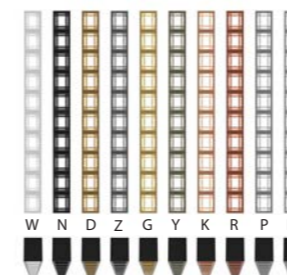

## PROFILE VIEW

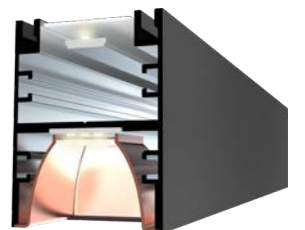

Down to UGR ≤ 16 | up to 140 lm/W | up to 4383 lm/m | IEC 62471: Blue light hazard: RG 0 | DALI switchDIM



# quadro

Hängeleuchte  
Pendant luminaire  
Suspension



QUADRO | PENDANT

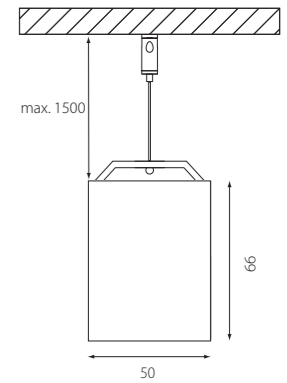
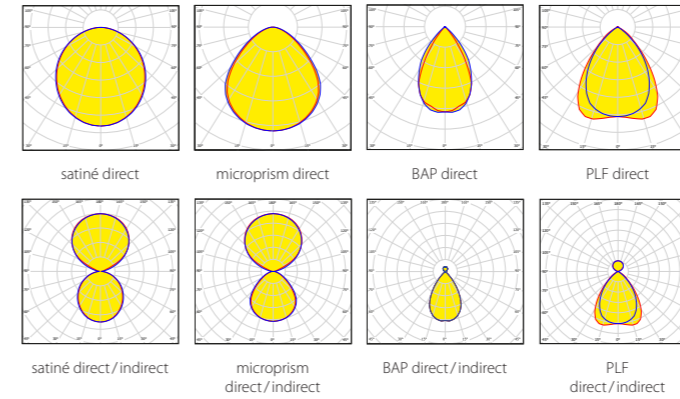

| 1 VERSION                                       | 2 SIZE   | 3 COLOUR   |
|---|--|--|
| quadro  | <b>S</b> BAP BAP Sensor  | silver <b>9006</b>   |
| <b>NEW</b> quadro.green                         | <b>G</b> 1124 mm <b>112</b> 1194 mm <b>119</b>                     | white <b>9016</b>  |
|   | 1404 mm <b>140</b> 1474 mm <b>147</b>                              | black <b>9005</b>  |
|   | 1684 mm <b>168</b>   | RAL of your choice   |
|   | 2244 mm <b>224</b>   |  |
|   | 2804 mm <b>280</b>   |  |
|   | 3364 mm <b>336</b>   |  |
|   | <b>satiné/microprism</b> <b>satiné/microprism</b><br>Sensor Sensor |  |
|   | 1130 mm <b>113</b> 1200 mm <b>120</b>                              |  |
|   | 1410 mm <b>141</b> 1480 mm <b>148</b>                              |  |
|   | 1690 mm <b>169</b>   |  |
|   | 2250 mm <b>225</b>   |  |
|   | 2810 mm <b>281</b>   |  |
|   | 3370 mm <b>337</b>   |  |
| 5 LED   | 6 OUTPUT/CONTROL   | 7 OPTIC  |
| 3000 K, CRI > 80 <b>830</b>                     | no Sensor with Sensor  | satiné <b>S</b> BAP white (RAL 9016)* <b>W</b>                                   |
| 4000 K, CRI > 80 <b>840</b>                     | low output non-dim <b>L1</b> -                                     | microprism* <b>M</b> BAP black (RAL 9005)* <b>N</b>                              |
| 3000 K, CRI > 90 <b>930</b>                     | low output DALI <b>L3</b> <b>L7</b>                                | BAP high-gloss silver* <b>B</b> BAP glaring gold* <b>D</b>                       |
| 4000 K, CRI > 90 <b>940</b>                     | high output DALI <b>H3</b> <b>H7</b>                               | BAP silver matte* <b>P</b> BAP capital copper* <b>R</b>                          |
| 2700-6500 K, dynamic white, CRI > 90 <b>HCL</b> | dynamic white <b>X3</b> <b>X7</b><br>(on request)                  | BAP high-gloss gold* <b>G</b> BAP gunnery grey* <b>Y</b>                         |
|   |  | BAP high-gloss copper* <b>K</b> BAP high gloss black chrome* <b>Z</b> <b>NEW</b> |
|   |  | PLF Parabolic Louvre Flat silver semi-matte* <b>F</b> <b>NEW</b>                 |

T6 1 H 2 - 3 C 4 4 5 6 7

T65H112-9016C1840H3P quadro pendant, 1124 mm, white, IP20, direct, 4000 K, CRI > 80, high output DALI, BAP silver matte (order sample)

► Configure online on [KATALOG.PLANLICHT.COM](http://KATALOG.PLANLICHT.COM)

LUMINOUS FLUX (LM) / SYSTEM POWER (W)

| 4000K satiné | direct              |                      |                        | direct/indirect     |                      |                        | max    |
|--------------|---------------------|----------------------|------------------------|---------------------|----------------------|------------------------|--------|
|              | low output CRI > 80 | high output CRI > 80 | dynamic white CRI > 90 | low output CRI > 80 | high output CRI > 80 | dynamic white CRI > 90 |        |
| 1124 mm      | 1596 lm / 14 W      | 2772 lm / 23 W       | 2098 lm / 24 W         | 3521 lm / 25 W      | 6116 lm / 45 W       | 4629 lm / 44 W         | 3,1 kg |
| 1404 mm      | 2000 lm / 16 W      | 3474 lm / 30 W       | 2630 lm / 29 W         | 4439 lm / 31 W      | 7710 lm / 54 W       | 5837 lm / 55 W         | 3,7 kg |
| 1684 mm      | 2403 lm / 19 W      | 4174 lm / 35 W       | 3160 lm / 35 W         | 5355 lm / 37 W      | 9301 lm / 64 W       | 7041 lm / 65 W         | 4,7 kg |
| 2244 mm      | 3207 lm / 25 W      | 5570 lm / 46 W       | 4216 lm / 45 W         | 7186 lm / 50 W      | 12481 lm / 86 W      | 9448 lm / 89 W         | 6,2 kg |
| 2804 mm      | 4008 lm / 31 W      | 6960 lm / 55 W       | 5269 lm / 56 W         | 9014 lm / 63 W      | 15654 lm / 108 W     | 11850 lm / 110 W       | 7,7 kg |
| 3364 mm      | 4805 lm / 37 W      | 8344 lm / 66 W       | 6316 lm / 66 W         | 10839 lm / 75 W     | 18822 lm / 130 W     | 14248 lm / 132 W       | 9,7 kg |

(based on optic S, DALI)

COMPARE COVER 1404 MM, 4000 K, CRI > 80

|                         | direct              |                      |                        | direct/indirect     |                      |                        |
|-------------------------|---------------------|----------------------|------------------------|---------------------|----------------------|------------------------|
|                         | low output CRI > 80 | high output CRI > 80 | dynamic white CRI > 90 | low output CRI > 80 | high output CRI > 80 | dynamic white CRI > 90 |
| satiné                  | 2000 lm / 16 W      | 3474 lm / 30 W       | 2630 lm / 29 W         | 4439 lm / 31 W      | 7710 lm / 54 W       | 5837 lm / 55 W         |
| microprism              | 1580 lm / 16 W      | 2745 lm / 30 W       | 2078 lm / 29 W         | 4019 lm / 31 W      | 6981 lm / 54 W       | 5285 lm / 55 W         |
| high-gloss silver       | 3005 lm / 23 W      | 5869 lm / 47 W       | 4656 lm / 48 W         | 3715 lm / 27 W      | 7277 lm / 56 W       | 5773 lm / 56 W         |
| silver matte            | 2603 lm / 23 W      | 5083 lm / 47 W       | 4033 lm / 48 W         | 3313 lm / 27 W      | 6491 lm / 56 W       | 5150 lm / 56 W         |
| high-gloss gold         | 2748 lm / 23 W      | 5367 lm / 47 W       | 4232 lm / 48 W         | 3458 lm / 27 W      | 6775 lm / 56 W       | 5375 lm / 56 W         |
| high-gloss copper       | 2731 lm / 23 W      | 5334 lm / 47 W       | 4380 lm / 48 W         | 3441 lm / 27 W      | 6742 lm / 56 W       | 5349 lm / 56 W         |
| BAP white               | 2827 lm / 23 W      | 5521 lm / 47 W       | 4377 lm / 23 W         | 3537 lm / 27 W      | 6929 lm / 56 W       | 5497 lm / 56 W         |
| BAP black               | 1495 lm / 23 W      | 2920 lm / 47 W       | 2316 lm / 48 W         | 2205 lm / 27 W      | 4328 lm / 56 W       | 3433 lm / 56 W         |
| glaring gold            | 1749 lm / 23 W      | 3416 lm / 47 W       | 2710 lm / 48 W         | 2459 lm / 27 W      | 4824 lm / 56 W       | 3827 lm / 56 W         |
| capital copper          | 1589 lm / 23 W      | 3104 lm / 47 W       | 2463 lm / 48 W         | 2299 lm / 27 W      | 4512 lm / 56 W       | 3580 lm / 56 W         |
| gunnery grey            | 1767 lm / 23 W      | 3451 lm / 47 W       | 2738 lm / 48 W         | 2477 lm / 27 W      | 4859 lm / 56 W       | 3855 lm / 56 W         |
| high gloss black chrome | 2260 lm / 23 W      | 4415 lm / 47 W       | 3502 lm / 48 W         | 2970 lm / 27 W      | 5823 lm / 56 W       | 4619 lm / 56 W         |
| parabolic louvre flat   | 3457 lm / 29 W      | 5319 lm / 47 W       | 4220 lm / 48 W         | 4348 lm / 34 W      | 6727 lm / 56 W       | 5337 lm / 56 W         |

COMPARE LIGHT COLOUR 1414 MM, BAP SILVER MATTE

|                  |         |       |
|------------------|---------|-------|
| 4000 K, CRI > 80 | 2603 lm | +4,5% |
| 4000 K, CRI > 90 | 2721 lm |       |
| 3000 K, CRI > 80 | 2483 lm | +4,5% |
| 3000 K, CRI > 90 | 2595 lm |       |

5 BAP LOUVRE COLOURS

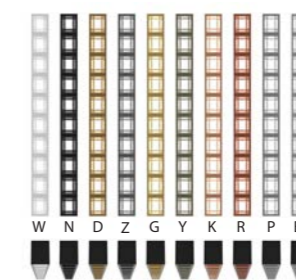

PROFILE VIEW



Down to UGR ≤ 16 | up to 146 lm/W | up to 5585 lm/m | IEC 62471: Blue light hazard: RG ≤ 1 | DALI switchDIM

# quadro office special

Hängeleuchte  
Pendant luminaire  
Suspension

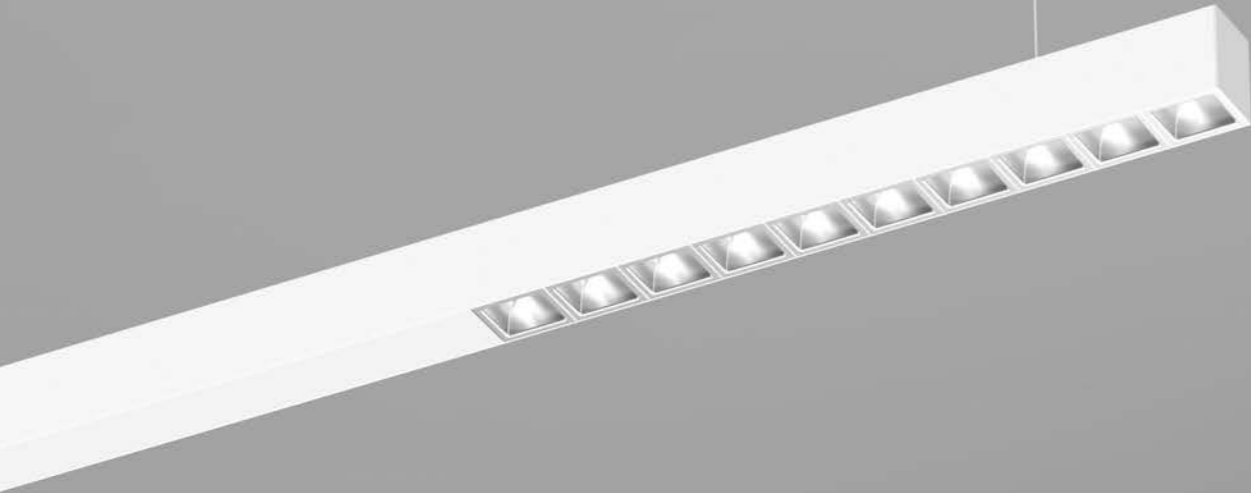

## QUADRO OFFICE SPECIAL | PENDANT

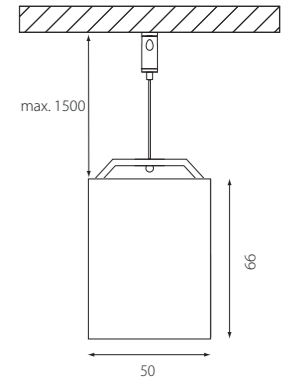
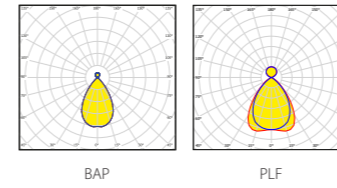

### LUMINOUS FLUX (LM) / SYSTEM POWER (W)

| 4000 K silver matte | low output CRI > 80 | high output CRI > 80 | dynamic white CRI > 90 |        |
|---------------------|---------------------|----------------------|------------------------|--------|
| 1404 mm             | 2793 lm / 23 W      | 5475 lm / 47 W       | 4344 lm / 48 W         | 3,3 kg |
| 1684 mm             | 2936 lm / 24 W      | 5757 lm / 49 W       | 4568 lm / 49 W         | 4,5 kg |
| 3364 mm             | 5584 lm / 46 W      | 10948 lm / 94 W      | 8686 lm / 96 W         | 9,5 kg |

(based on optic S, DALI)

### COMPARE BAP LOUVRES 1404 MM

|   | low output CRI > 80 | high output CRI > 80 | dynamic white CRI > 90 |
|---|---------------------|----------------------|------------------------|
| B | 3115 lm             | 6104 lm              | 4843 lm                |
| P | 2793 lm             | 5475 lm              | 4344 lm                |
| G | 2909 lm             | 5702 lm              | 4524 lm                |
| K | 2895 lm             | 5676 lm              | 4503 lm                |
| W | 2972 lm             | -                    | -                      |
| N | 1906 lm             | 3744 lm              | 2971 lm                |
| D | 2110 lm             | 4142 lm              | 3286 lm                |
| R | 1982 lm             | 3892 lm              | 3088 lm                |
| Y | 2124 lm             | 4169 lm              | 3308 lm                |
| Z | 2519 lm             | 4941 lm              | 3920 lm                |
| F | 3657 lm             | 5664 lm              | 4493 lm                |

### QUADRO OFFICE SPECIAL 1404 MM

Ideal for table size 1600x800 mm

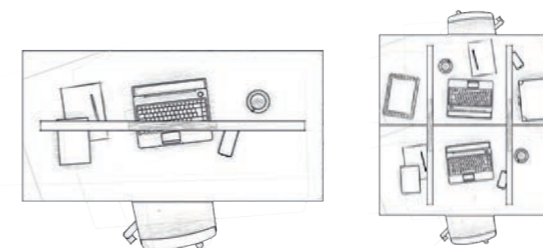
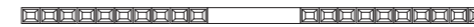

### QUADRO OFFICE SPECIAL 1684 MM

Ideal for table of 1800 or 2000x1000 mm

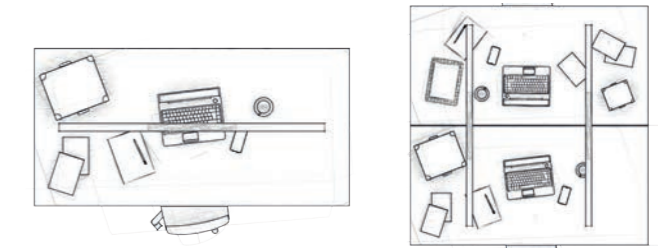

### QUADRO OFFICE SPECIAL 3364 MM

Ideal for two tables of 1800 or 2000x1000 mm

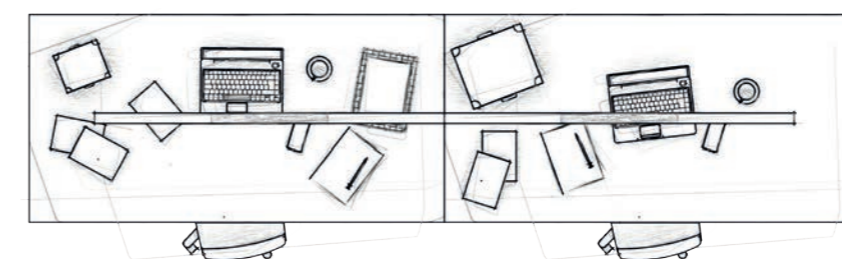

#### 1 VERSION

|                         |          |
|-------------------------|----------|
| quadro                  | <b>S</b> |
| <b>NEW</b> quadro.green | <b>G</b> |

#### 2 SIZE

|         |            |
|---------|------------|
| 1404 mm | <b>14X</b> |
| 1684 mm | <b>16X</b> |
| 3364 mm | <b>33X</b> |

#### 3 COLOUR

|  |                    |             |
|--|--------------------|-------------|
|  | silver             | <b>9006</b> |
|  | white              | <b>9016</b> |
|  | black              | <b>9005</b> |
|  | RAL of your choice |             |

#### 4 LED

|  |                                      |            |
|--|--------------------------------------|------------|
|  | 3000 K, CRI > 80                     | <b>830</b> |
|  | 4000 K, CRI > 80                     | <b>840</b> |
|  | 3000 K, CRI > 90                     | <b>930</b> |
|  | 4000 K, CRI > 90                     | <b>940</b> |
|  | 2700-6500 K, dynamic white, CRI > 90 | <b>HCL</b> |

#### 5 OUTPUT/CONTROL

|  | no Sensor                    | with Sensor               |
|--|------------------------------|---------------------------|
|  | low output non-dim <b>L1</b> | -                         |
|  | low output DALI <b>L3</b>    | <b>L7</b>                 |
|  | high output DALI <b>H3</b>   | <b>H7</b>                 |
|  | dynamic white <b>X3</b>      | <b>X7</b><br>(on request) |

#### 6 OPTIC

|                        |          |                              |                     |
|------------------------|----------|------------------------------|---------------------|
| BAP high-gloss silver* | <b>B</b> | BAP black (RAL 9005)*        | <b>N</b>            |
| BAP silver matte*      | <b>P</b> | BAP glaring gold*            | <b>D</b>            |
| BAP high-gloss gold*   | <b>G</b> | BAP capital copper*          | <b>R</b>            |
| BAP high-gloss copper* | <b>K</b> | BAP gunnery grey*            | <b>Y</b>            |
| BAP white (RAL 9016)*  | <b>W</b> | BAP high gloss black chrome* | <b>Z</b> <b>NEW</b> |
|                        |          | PLF Parabolic Louvre         | <b>F</b> <b>NEW</b> |
|                        |          | Flat silver semi-matte*      |                     |

\* UGR-optimised, configure online

T6 **1**H **2**-**3**C **2** **4** **5** **6**

T65H16X-9005C2830H3B Pendant, 1684 mm, black, IP 20, direct/indirect, 3000 K, CRI > 80, high output DALI, BAP high-gloss silver (order sample)

► [Configure online on KATALOG.PLANLICHT.COM](https://www.planlicht.com)



Down to UGR ≤ 16 | up to 150 lm/W | IEC 62471: Blue light hazard: RG 0 | DALI switchDIM



## 2 SIZE

1498 mm  
1778 mm  
3458 mm

**15X**  
**17X**  
**34X**

## 3 ACOUSTIC MODULE

- QUIET.FELT standard anthracite melange **QA**
- QUIET.FELT standard pebble **QP**
- QUIET.FELT standard lime **QL**
- QUIET.FELT extra+ black \* **QB**
- QUIET.FELT extra+ fire \* **QF**
- QUIET.FELT extra+ light grey melange \* **QG**
- QUIET.FELT extra+ chocolate \* **QC**
- Organoid® Mous \* **QM**
- Organoid® Wollä \* **QW**
- Organoid® Wildspitze \* **QH**

\*on request

## 1 VERSION

- quadro **S**
- quadro.green **G** **NEW**

## 4 HOUSING COLOUR

- silver **SI**
- white **WS**
- black **SW**
- RAL of your choice

## 5 LED

- 3000 K, CRI > 80
- 4000 K, CRI > 80
- 3000 K, CRI > 90
- 4000 K, CRI > 90
- 2700 - 6500 K, dynamic white, CRI > 90

**830**  
**840**  
**930**  
**940**  
**HCL**

## 6 OUTPUT/CONTROL

- |  |                              |            |
|--|------------------------------|------------|
|  | non Sensor                   | Sensor     |
|  | low output non-dim <b>L1</b> | -          |
|  | low output DALI <b>L3</b>    | <b>L7</b>  |
|  | high output DALI <b>H3</b>   | <b>H7</b>  |
|  | dynamic white <b>X3</b>      | <b>X7*</b> |

\*on request

## 7 BAP LOUVRE COLOURS

- |                                   |          |  |                     |
|-----------------------------------|----------|--|---------------------|
| BAP high-gloss silver*            | <b>B</b> | BAP glaring gold*                            | <b>D</b>            |
| BAP silver matte*                 | <b>P</b> | BAP capital copper*                          | <b>R</b>            |
| BAP high-gloss gold*              | <b>G</b> | BAP gunnery grey*                            | <b>Y</b>            |
| BAP high-gloss copper*            | <b>K</b> | BAP high gloss black chrome*                 | <b>Z</b>            |
| BAP white (RAL 9016, low output)* | <b>W</b> | BAP high gloss black chrome*                 | <b>Z</b> <b>NEW</b> |
| BAP black (RAL 9005)*             | <b>N</b> | PLF Parabolic Louvre Flat silver semi-matte* | <b>F</b> <b>NEW</b> |

\*UGR-optimised, configure online

T6 **1** **H** **2** - **3** **4** **C2** **5** **6** **7**

T65H17X-QLSWC2840H3Y pendant, 1178 mm, lime acoustic module, housing black, IP20, direct & indirect, 4000 K, CRI > 80, high output DALI, BAP gunnery grey (order sample) [Configure online on KATALOG.PLANLICHT.COM](#)

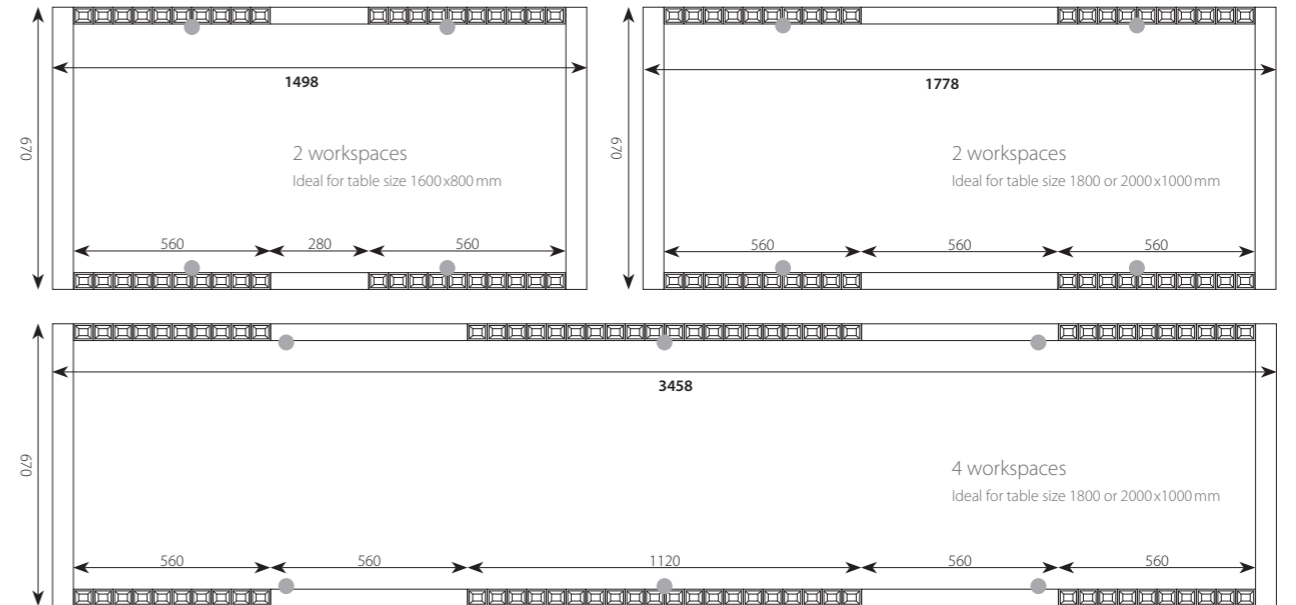
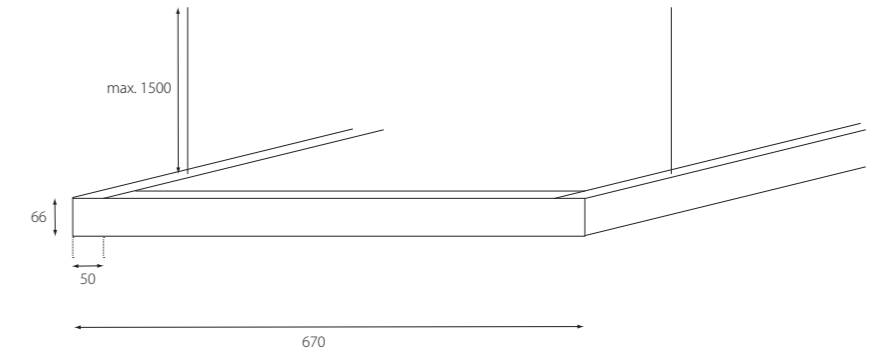
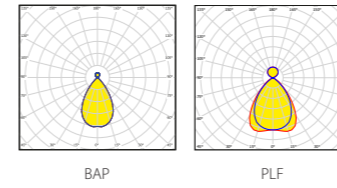

## LUMINOUS FLUX (LM) / SYSTEM POWER (W)

| 4000K BAP silver matte | low output CRI > 80 | high output CRI > 80 | dynamic white CRI > 90 |       |
|------------------------|---------------------|----------------------|------------------------|-------|
| 1498x670 mm            | 5584 lm / 46W       | 10948 lm / 94W       | 8686 lm / 96W          | 16 kg |
| 1778x670 mm            | 5869 lm / 47W       | 11512 lm / 98W       | 9133 lm / 99W          | 17 kg |
| 3458x670 mm            | 11167 lm / 91W      | 21893 lm / 188W      | 17368 lm / 192W        | 31 kg |

## COMPARE BAP LOUVRES 1498 x 670 MM

|   | low output CRI > 80 | high output CRI > 80 | dynamic white CRI > 90 |
|---|---------------------|----------------------|------------------------|
| B | 6228 lm             | 12205 lm             | 8693 lm                |
| P | 5584 lm             | 10948 lm             | 8686 lm                |
| G | 5816 lm             | 11402 lm             | 9046 lm                |
| K | 5789 lm             | 11349 lm             | 9004 lm                |
| W | 4247 lm             | -                    | -                      |
| N | 3812 lm             | 7488 lm              | 5940 lm                |
| D | 4219 lm             | 8282 lm              | 6570 lm                |
| R | 3963 lm             | 7783 lm              | 6174 lm                |
| Y | 4247 lm             | 8337 lm              | 6614 lm                |
| Z | 5037 lm             | 9879 lm              | 7837 lm                |
| F | 7313 lm             | 11325 lm             | 8985 lm                |



Down to UGR ≤ 16 | up to 145 lm/W | up to 3922 lm/m | IEC 62471: Blue light hazard: RG 0 | DALI switchDIM

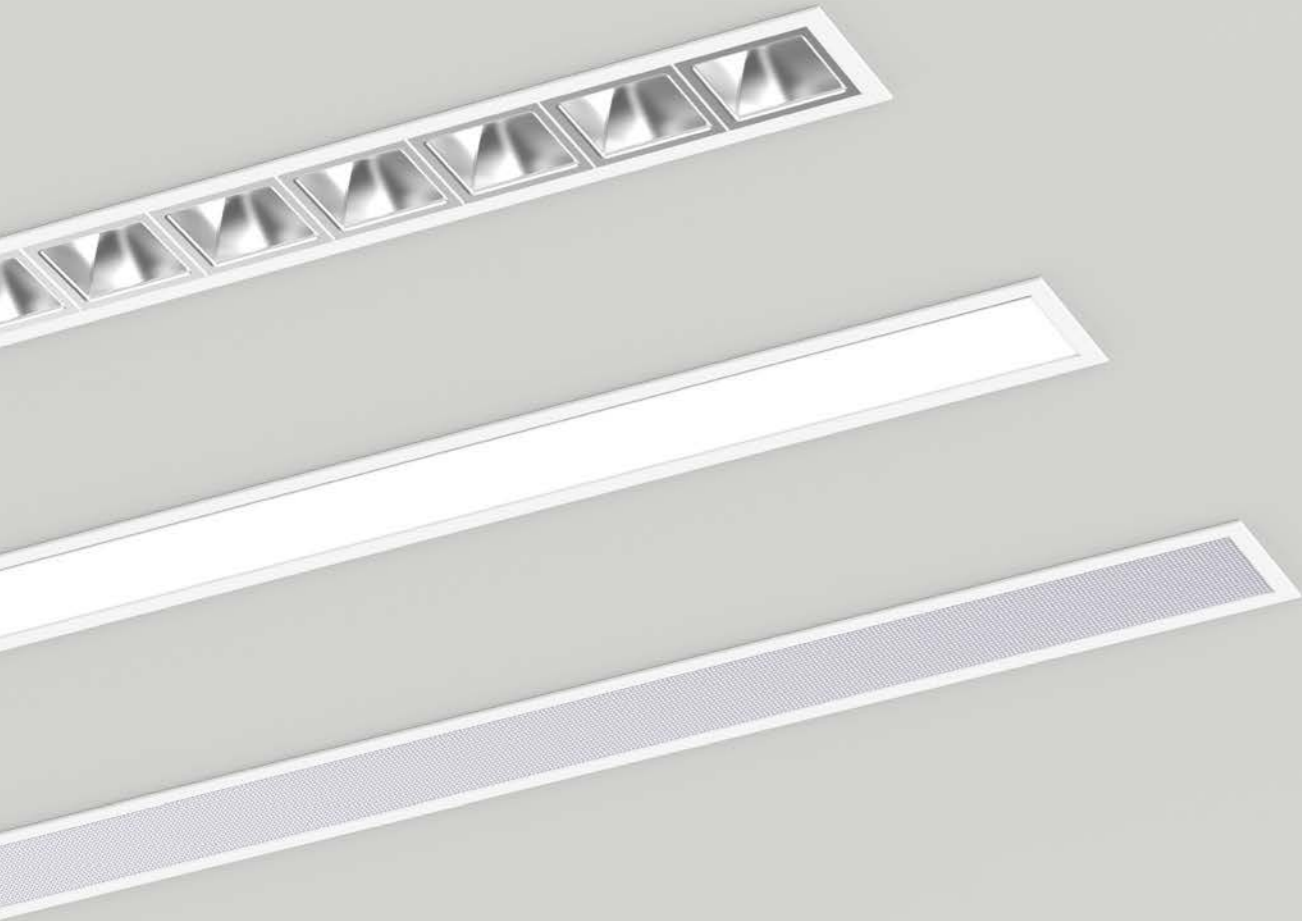

### 1 SIZE

| no Sensor | with Sensor                   |
|-----------|-------------------------------|
| 576 mm    | <b>057</b>                    |
| 1136 mm   | <b>113</b> 1206 mm <b>120</b> |
| 1416 mm   | <b>141</b> 1486 mm <b>148</b> |
| 1696 mm   | <b>169</b>                    |
| 2256 mm   | <b>225</b>                    |

### 2 COLOUR

|  |                    |             |
|--|--------------------|-------------|
|  | silver             | <b>9006</b> |
|  | white              | <b>9016</b> |
|  | black              | <b>9005</b> |
|  | RAL of your choice |             |

### 3 LED

|  |                                       |            |
|--|---------------------------------------|------------|
|  | 3000 K, CRI > 80                      | <b>830</b> |
|  | 4000 K, CRI > 80                      | <b>840</b> |
|  | 3000 K, CRI > 90                      | <b>930</b> |
|  | 4000 K, CRI > 90                      | <b>940</b> |
|  | 2700 - 6500 K dynamic white, CRI > 90 | <b>HCL</b> |

### 4 OUTPUT / CONTROL

| no Sensor | with Sensor                  |
|-----------|------------------------------|
|           | low output non-dim <b>L1</b> |
|           | low output DALI <b>L3</b>    |
|           | high output DALI <b>H3</b>   |
|           | dynamic white <b>X3</b>      |

Dynamic white with Sensor on request (X7)

### 5 OPTIC

|                        |          |                              |                     |
|------------------------|----------|------------------------------|---------------------|
| satiné                 | <b>S</b> | BAP white (RAL 9016)*        | <b>W</b>            |
| microprism*            | <b>M</b> | BAP black (RAL 9005)*        | <b>N</b>            |
| BAP high-gloss silver* | <b>B</b> | BAP glaring gold*            | <b>D</b>            |
| BAP silver matte*      | <b>P</b> | BAP capital copper*          | <b>R</b>            |
| BAP high-gloss gold*   | <b>G</b> | BAP gunnery grey*            | <b>Y</b>            |
| BAP high-gloss copper* | <b>K</b> | BAP high-gloss black chrome* | <b>Z</b> <b>NEW</b> |

\* UGR-optimised, configure online

T65E 1-2 C1 3 4 5

T65E057-9016C1840H3B frame, 576 mm, white, IP20, direct, 4000 K, CRI > 80, high output DALI, BAP high-gloss silver (order sample)

► [Configure online on KATALOG.PLANLICHT.COM](#)

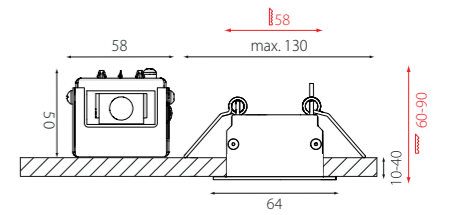
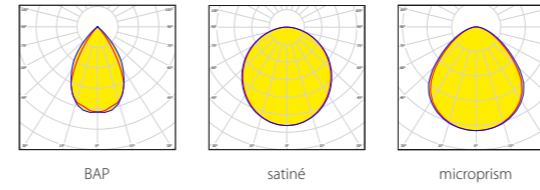

### LUMINOUS FLUX (LM) / SYSTEM POWER (W)

| 4000 K BAP silver matte | low output CRI > 80 | high output CRI > 80 | dynamic white CRI > 90 |        |
|-------------------------|---------------------|----------------------|------------------------|--------|
| 576 mm                  | 1042 lm / 10W       | 2036 lm / 20W        | 1615 lm / 21W          | 2,0 kg |
| 1136 mm                 | 2083 lm / 19W       | 4067 lm / 38W        | 3227 lm / 39W          | 2,8 kg |
| 1416 mm                 | 2603 lm / 23W       | 5083 lm / 47W        | 4033 lm / 48W          | 3,1 kg |
| 1696 mm                 | 3123 lm / 27W       | 6099 lm / 56W        | 4839 lm / 57W          | 3,4 kg |
| 2256 mm                 | 4163 lm / 37W       | 8131 lm / 73W        | 6451 lm / 74W          | 4,0 kg |

(based on DALI)

### CUT OUT

| SIZE               | WIDTH | DEPTH      |
|--------------------|-------|------------|
| all lengths - 6 mm | 58 mm | 60 - 90 mm |

### COMPARE COVER 1416 MM, 4000 K, CRI > 80

|                         | low output CRI > 80 | high output CRI > 80 | dynamic white CRI > 90 |
|-------------------------|---------------------|----------------------|------------------------|
| satiné                  | 2000 lm / 16W       | 3474 lm / 30W        | 2630 lm / 29W          |
| microprism              | 1580 lm / 16W       | 2745 lm / 30W        | 2078 lm / 29W          |
| high-gloss silver       | 3005 lm / 23W       | 5869 lm / 47W        | 4656 lm / 48W          |
| silver matte            | 2603 lm / 23W       | 5083 lm / 47W        | 4033 lm / 48W          |
| high-gloss gold         | 2748 lm / 23W       | 5367 lm / 47W        | 4258 lm / 48W          |
| high-gloss copper       | 2731 lm / 23W       | 5334 lm / 47W        | 4232 lm / 48W          |
| BAP white               | 2827 lm / 23W       | 5521 lm / 47W        | 4380 lm / 48W          |
| BAP black               | 1495 lm / 23W       | 2920 lm / 47W        | 2316 lm / 48W          |
| glaring gold            | 1749 lm / 23W       | 3416 lm / 47W        | 2710 lm / 48W          |
| capital copper          | 1589 lm / 23W       | 3104 lm / 47W        | 2463 lm / 48W          |
| gunnery grey            | 1767 lm / 23W       | 3451 lm / 47W        | 2738 lm / 48W          |
| high-gloss black chrome | 2260 lm / 23W       | 4415 lm / 47W        | 3502 lm / 48W          |

### COMPARE LIGHT COLOUR 1416 MM, BAP SILVER MATTE

|                  |         |         |
|------------------|---------|---------|
| 4000 K, CRI > 80 | 5083 lm |         |
| 4000 K, CRI > 90 | 5313 lm | + 4,5 % |
| 3000 K, CRI > 80 | 4850 lm |         |
| 3000 K, CRI > 90 | 5068 lm | + 4,5 % |

### 5 BAP LOUVRE COLOURS

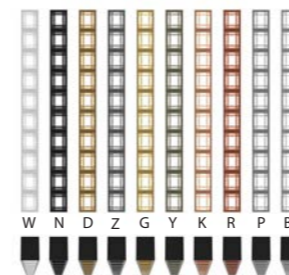

### OPTIONAL ACCESSORIES

|                      |                      |
|----------------------|----------------------|
| <b>T65-DVS1</b>      | Loop-connection-set  |
| <b>T65-ENDS-9005</b> | End cap - set black  |
| <b>T65-ENDS-9006</b> | End cap - set silver |
| <b>T65-ENDS-9016</b> | End cap - set white  |

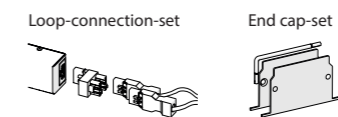

### PROFILE VIEW



Down to UGR ≤ 16 | up to 149 lm / W | up to 4183 lm / m | IEC 62471: Blue light hazard: RG 0 | DALI switchDIM

# FARBKARTEN | GEHÄUSE & KABEL

## COLOUR CHARTS | HOUSING & CABLES

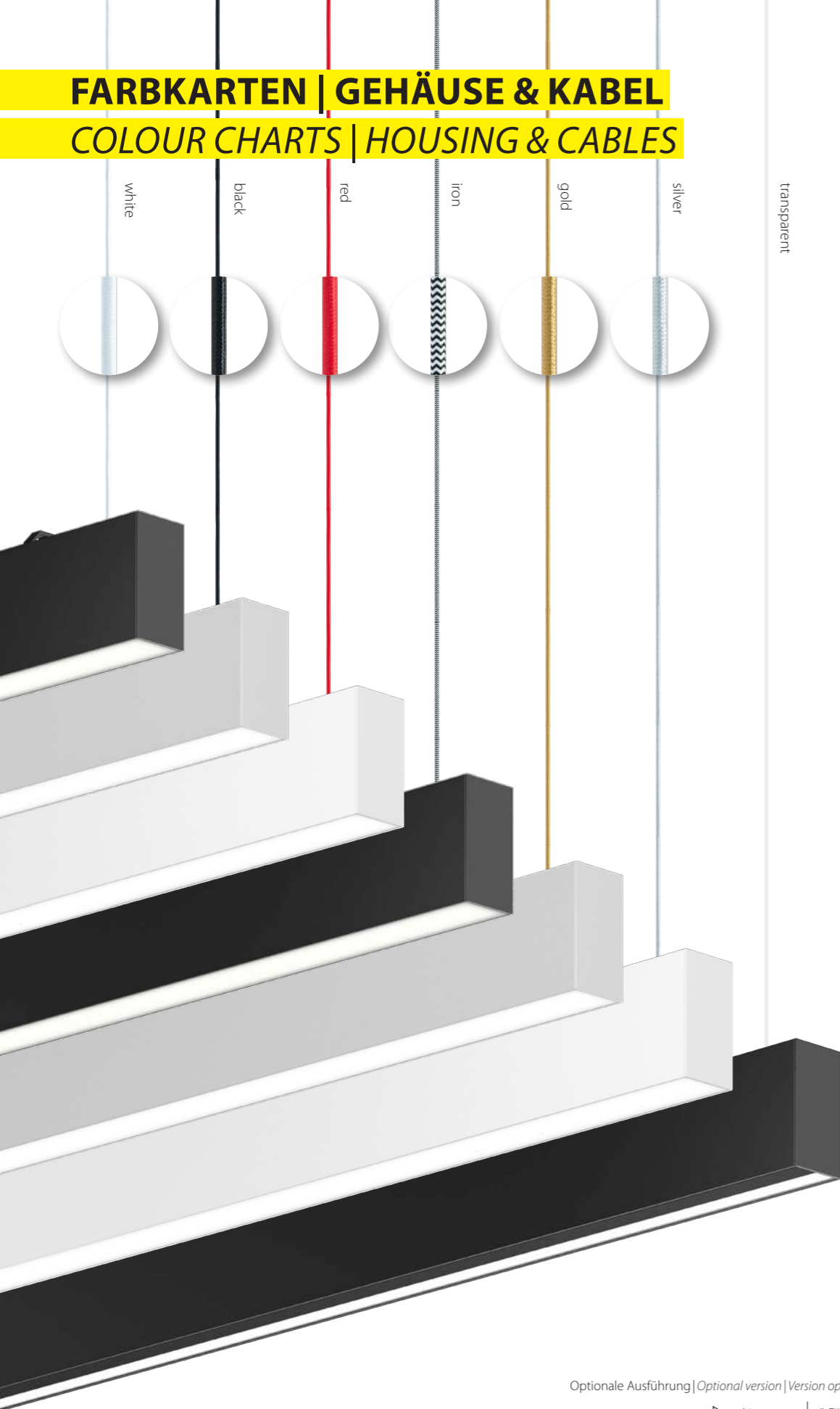

Optionale Ausführung | Optional version | Version optionnelle

|          |              |
|----------|--------------|
| ▷ white  | *-EIN-WHITE  |
| ▷ black  | *-EIN-BLACK  |
| ▷ red    | *-EIN-RED    |
| ▷ iron   | *-EIN-IRON   |
| ▷ gold   | *-EIN-GOLD   |
| ▷ silver | *-EIN-SILVER |

1750mm  
5x0,75mm²

Transparentes Kabel inkl. (Standard Version)



für besondere Anfragen

# RAL NACH WAHL | OPTIONALE GEHÄUSEFARBEN

## RAL OF YOUR CHOICE | OPTIONAL HOUSING COLOURS



**FARBKARTEN | RASTER, MASKEN & TUBI**

**COLOUR CHARTS | LOUVRES, MASKS & TUBES**

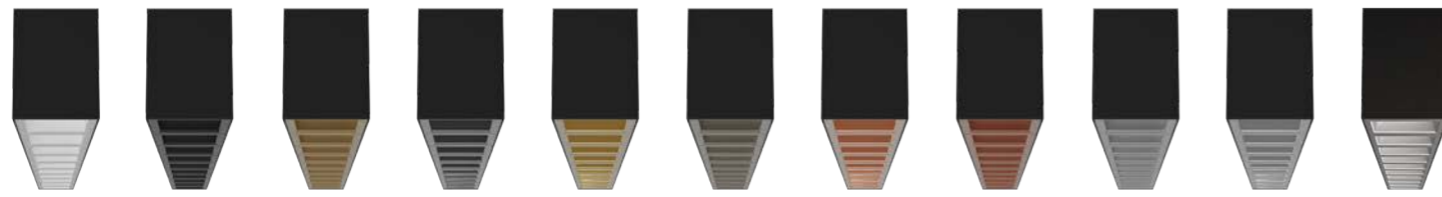
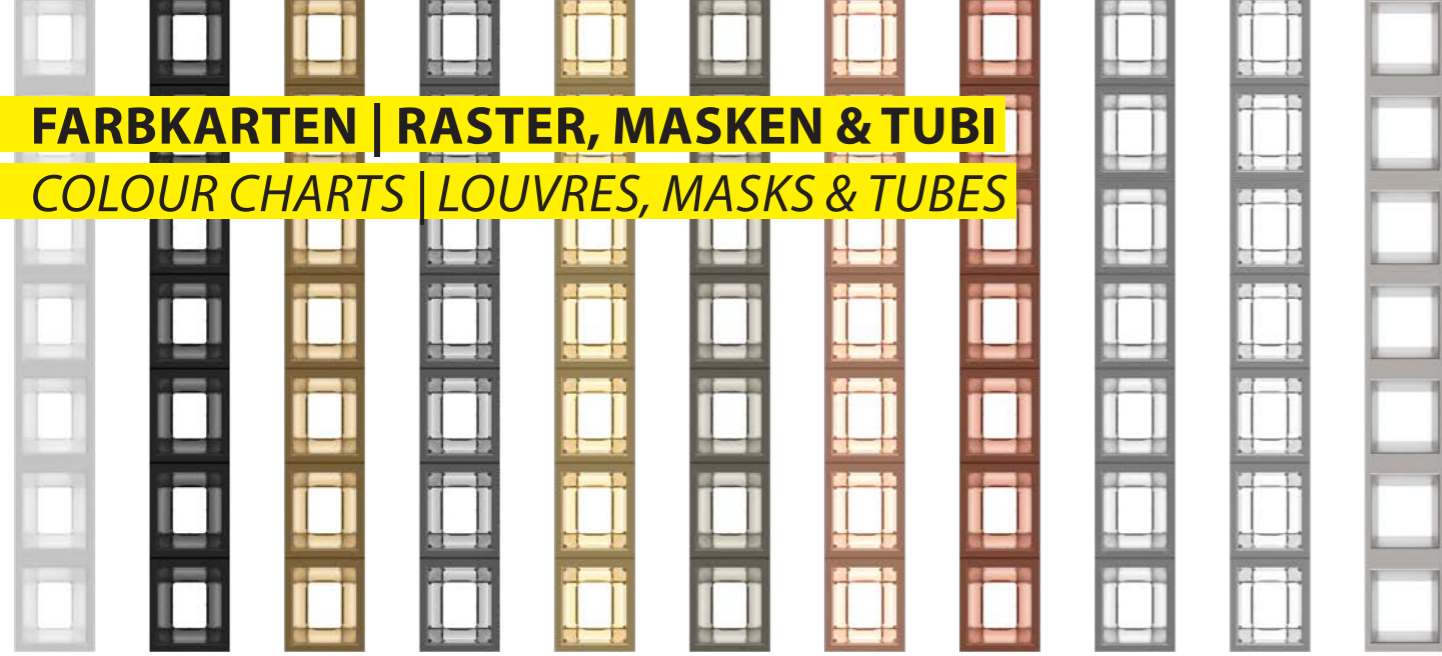

white 9019    black 9005    glaring gold    high-gloss black chrome    high-gloss gold    gunnery grey    high-gloss copper    capital copper    silver matte    high-gloss silver    PLF Raster

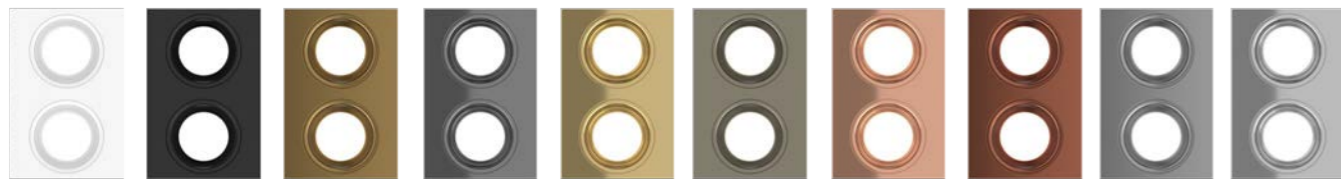

**FARBKARTEN | DIFFUSOREN & OPTIKEN**

**COLOUR CHARTS | DIFFUSERS & OPTICS**



**ORGANOID®**



WILDSPITZE  
[vɪltʃpɪtsə]



WOLLÄ  
[ˈvɔlə]

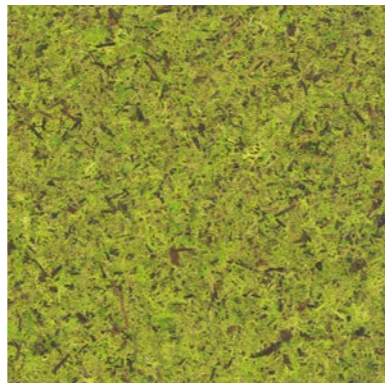

MOUS  
[ˈməʊz]

**FELT.QUIET**

STANDARD



ANTHRACITE MELANGE



LIME



PEBBLE | KIESEL

EXTRA +

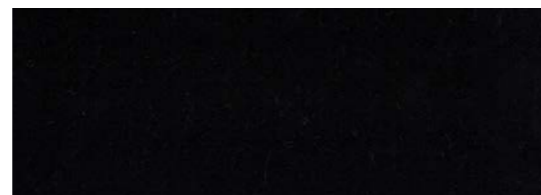

BLACK



FIRE

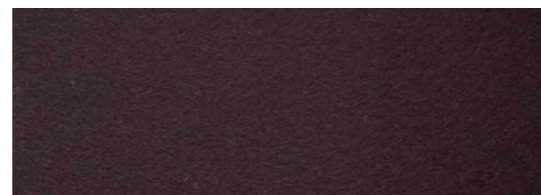

CHOCOLATE



LIGHT GREY MELANGE

A large grid of 20 columns and 30 rows for taking notes.

## WICHTIGE HINWEISE

Dieser Katalog richtet sich ausschliesslich an gewerbliche Kunden. Die in diesem Katalog angegebenen Werte sind Bemessungswerte und unterliegen produktionsbedingten Toleranzen\*. Alle angeführten Angaben – insbesondere Grössen-, Material-, Farb- und technische Angaben – entsprechen dem Stand zum Zeitpunkt des Drucks und dienen ausschliesslich zur Information. Der Herausgeber haftet nicht für Satz- und Druckfehler sowie für Abweichungen der Produkte von Abbildungen und Angaben. PLANLICHT behält sich vor, jederzeit ohne Ankündigung Änderungen an Produkten vor zu nehmen. Es gelten die Allgemeinen Geschäftsbedingungen der planlicht GmbH & Co KG, die unter WWW.PLANLICHT.COM eingesehen werden können.

Technische Kennzahlen, angeführte Werte und die Piktogramme betreffen zumindest einen aber nicht zwingend alle Artikel der jeweiligen Leuchtenfamilie, exakte Angaben je Artikel finden Sie im Online-Katalog bzw. in PLANLICHT-Verkaufsbelegen und Datenblättern.

\* Leistung, Lichtstrom und Farbtemperatur unterliegen durch den Einsatz von elektronischen Bauteilen produktionsbedingten Toleranzen. Toleranzen Leistung und Lichtstrom: +/- 10%. Toleranz Farbtemperatur: +/- 150 K. Lichtstrom dynamisch weiss bei 2700 K.

## IMPORTANT REMARKS

*This catalogue is reserved for professionals only. The values published in this catalogue are rated values, which can slightly change for reasons related to the production process\*. The published data such as dimensions, materials, colours and technical data are valid at time of printing, and exclusively provided for informational purposes. The editor takes no responsibility for typographical and print errors, as well as for any differences in the products, pictures and data. PLANLICHT reserves the right to change the products at any time and without any notice. The Terms and Conditions of planlicht GmbH & Co KG (available on WWW.PLANLICHT.COM) shall apply.*

*Key technical specifications, listed values as well as the pictogram bar relate to at least one but not necessarily all items of the respective luminaire family, exact details for each item can be found in the online web catalogue or in PLANLICHT sales documents and data sheets.*

\* The power output, luminous flux and colour temperature can be slightly different due to specific electronic components used in the manufacturing process. The power output and luminous flux can differ by +/- 10%. The colour temperature can differ by +/- 150 K. Luminous flux dynamic white at 2700 K.

## REMARQUES IMPORTANTES

*Ce catalogue est exclusivement destiné aux professionnels. Les valeurs publiées dans ce catalogue sont des valeurs calculées, pouvant légèrement changer pour des raisons liées au processus de fabrication\*. Les données techniques et autres informations (dimensions, matériaux, couleurs...) sont celles applicables au moment de l'impression du catalogue, et uniquement fournies à titre informatif. L'éditeur décline toute responsabilité en cas d'erreur de frappe, d'impression et pour tout autre différence concernant les produits, images et données publiées. PLANLICHT se réserve le droit de modifier les produits à sa discrétion, à tout moment et sans préavis. Les conditions générales de vente de planlicht GmbH & Co KG applicables sont consultables sur WWW.PLANLICHT.COM.*

*Les caractéristiques techniques, les valeurs indiquées et la barre de pictogrammes concernent au moins un article de la famille de luminaires concernée, mais pas nécessairement tous. Vous trouverez des informations exactes par article dans le catalogue en ligne ou dans les documents de vente et les fiches techniques de PLANLICHT.*

\* La puissance, le flux lumineux et la température de couleur peuvent légèrement différer en raison de l'utilisation de composants électroniques spécifiques dans le processus de production. La puissance et le flux lumineux peuvent différer de +/- 10%. La température de couleur peut différer de +/- 150 K. Flux lumineux blanc dynamique à 2700 K.



6134 Vomp, Austria, Au 25  
Tel. +43-5242-71608, Fax +43-5242-71283  
info@planlicht.com  
WWW.PLANLICHT.COM

## IMPRINT

**Publisher:** planlicht GmbH & Co. KG, Vomp  
**Creative Concept:** Katrin Atzinger  
**Graphic Design:** Beatrice Praxmarer, Christoph Höflinger  
**Print:** Himmer GmbH Druckerei & Verlag, Augsburg/DE  
© 2024





[WWW.PLANLICHT.COM](http://WWW.PLANLICHT.COM)