

p.bright

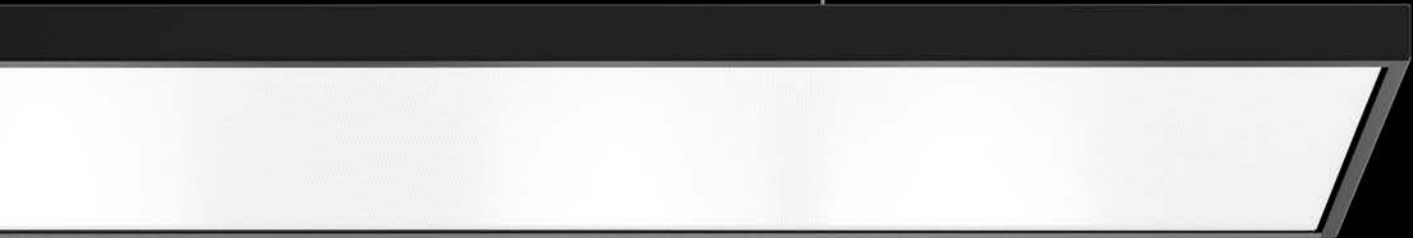



p.bright

**BRILLIANT. EFFICIENT.**

**VERSATILE.**

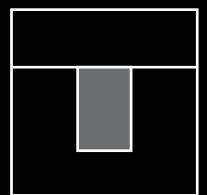

Surface

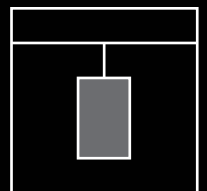

Pendant

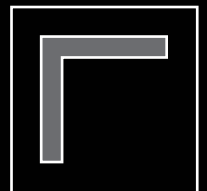

System



## P.BRIGHT - BRILLIANT. EFFICIENT. VERSATILE.

Inspiration

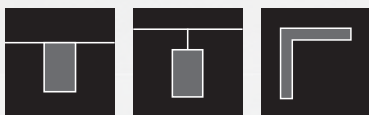



## MAXIMALE VARIABILITÄT

Erhältlich in sieben Längen und einem Ecksegment, als Einzeleuchte oder modulares Lichtbandsystem.

*Maximum Variability  
Variabilité maximale*



## VIELSEITIGER EINSATZ

Ideal für Schulen, Universitäten, Aulen, Großraumbüros und Open Work Spaces.

*Versatile Use  
Utilisation polyvalente*



## LGP-TECHNOLOGIE

Sorgt für präzise Lichtsteuerung und exzellente Energieeffizienz bei gleichmäßiger Ausleuchtung.

*LGP Technology for Maximum Efficiency  
Technologie LGP pour une efficacité maximale*



## FÖRDERBARKEIT UND EFFIZIENZ

Erfüllt die Förderkriterien mit bis zu 159 lm/W und >120 lm/W in jeder Konfiguration.

*Subsidy Eligibility and Efficiency  
Éligibilité aux subventions et efficacité*

## BLENDFREIE BELEUCHTUNG

Alle Low- & Medium-Output Varianten normkonform & blendfrei für arbeitsplatztaugliche Beleuchtung

*Glare-Free Lighting  
Éclairage sans éblouissement*

## FLEXIBLE MONTAGEOPTIONEN

Montage als Aufbauleuchte, Pendelleuchte oder halbeinbaufähig ohne zusätzliches Zubehör.

*Flexible Mounting Options  
Options de montage flexibles*

## ZUVERLÄSSIGER SCHUTZ (IP40)

Schutz vor dem Eindringen von Insekten ins Leuchteninnere für reduzierte Wartung und Einsatz in anspruchsvollen Innenräumen.

*Reliable protection (IP40)  
Protection fiable (IP40)*

## EINFACHE SERVICIERUNG

Ermöglicht den Austausch der LED-Platinen und des Treibers (teilweise nur durch den Hersteller) für eine verlängerte Lebensdauer.

*Sustainability through Easy Servicing  
Durabilité par un entretien facile*



## AUFBAUMONTAGE

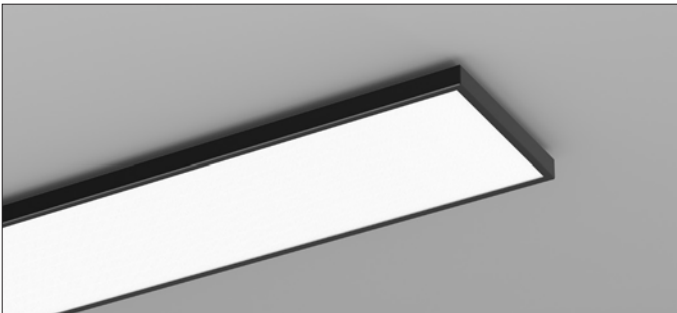

## HÄNGEMONTAGE



## MODULARES SYSTEM



# DAS PROFILSYSTEM FÜR HÖCHSTE FLEXIBILITÄT UND EFFIZIENZ

## **EINZELLEUCHTEN UND MODULARES LICHTBANDSYSTEM**

Die Produktfamilie p.bright vereint Vielseitigkeit und Präzision. Als Einzelleuchte im Profilsystem oder als modulares Lichtbandsystem lässt sie sich individuell anpassen. Mit sieben Längen und einem Ecksegment ermöglicht p.bright maßgeschneiderte Lichtlösungen – von durchgängigen Lichtbändern bis zu einzigartigen Lichtkonfigurationen, die sich nahtlos in anspruchsvolle Architektur integrieren lassen.

## **EFFIZIENZ DANK LGP-TECHNOLOGIE**

Ausgestattet mit der innovativen LGP-Technologie (Light Guiding Plate), bietet p.bright präzise Lichtsteuerung und außergewöhnliche Effizienz. Die gleichmäßige Ausleuchtung und die vielseitigen Gestaltungsmöglichkeiten machen diese Technologie zu einem zentralen Element des Systems.

## **INDIVIDUAL LUMINAIRES AND MODULAR SYSTEMS**

*The p.bright product family combines versatility with precision. Whether as an individual luminaire in the profile system or as a modular system, it can be tailored to meet your needs. With seven lengths and one corner segment, p.bright enables custom lighting solutions, from continuous linear lighting to unique configurations seamlessly integrated into sophisticated architecture.*

## **EFFICIENCY WITH LGP TECHNOLOGY**

*Equipped with innovative Light Guiding Plate (LGP) technology, p.bright ensures precise light deflection and outstanding efficiency. This technology delivers uniform illumination and versatile design possibilities, making it a core element of the system.*

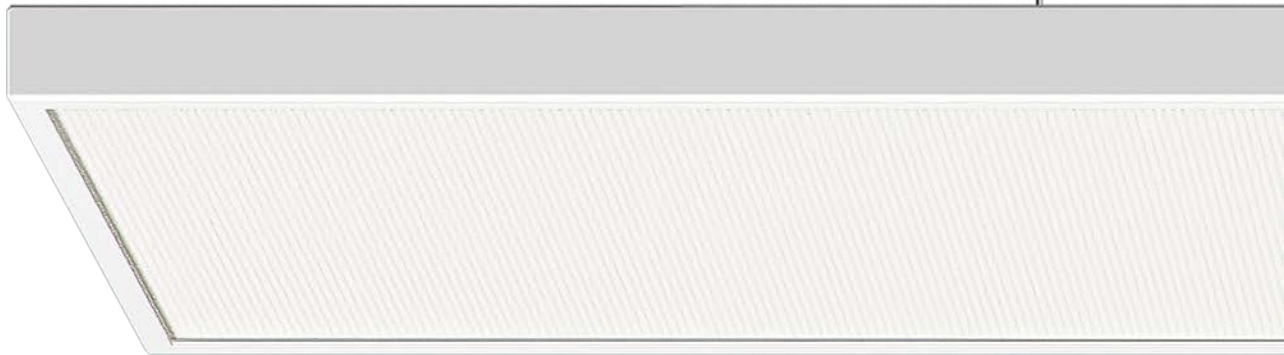

## PERFEKT FÜR ANSPRUCHSVOLLE UMGEBUNGEN

**Blendfreie, arbeitsplatztaugliche Beleuchtung** | Die mikroprismatische Optik garantiert einen maximalen Transmissionsgrad und ein extrem homogenes Lichtbild am Diffusor. Besonders hervorzuheben: Alle direkt/indirekt strahlenden Varianten sowie die Low- und Medium-Output-Ausführungen mit direkter Lichtabgabe erfüllen die Normen für blendfreie Beleuchtung ( $UGR \leq 19$ ) und eignen sich somit optimal für Arbeitsplätze.

**Einsatzvielfalt in komplexen Räumen** | p.bright ist prädestiniert für Anwendungen in Schulen, Universitäten, Aulen, aber auch in Großraumbüros und Open Work Spaces. Die flexible Montage als Aufbau- oder Hängeleuchte sowie die Möglichkeit zur halbeinbautauglichen Nutzung ohne Zubehör erweitern die Einsatzmöglichkeiten zusätzlich.

## PERFECT FOR DEMANDING ENVIRONMENTS

**Glare-free, workplace-suitable lighting** | *The microprismatic optic guarantees maximum transmission and an extremely homogeneous light distribution from the diffuser. Notable: All direct/indirect variants and low- and medium-output versions with direct light emission meet glare-free lighting standards ( $UGR \leq 19$ ), making them ideal for workplaces.*

**Versatility in complex spaces** | *p.bright is ideal for schools, universities, auditoriums, large offices, and open workspaces. Its flexible mounting options as a surface-mounted or suspended luminaire and semi-recessed installation without additional accessories broaden its application scope.*

## ÄSTHETIK UND QUALITÄT

**Direkte und indirekte Lichtabgabe** | Die Wahl zwischen direkter oder direkt/indirekter Lichtabgabe eröffnet vielfältige kreative Optionen, die Funktionalität und Ästhetik perfekt verbinden.

**Höchste Lichtqualität und Energieeffizienz** | Mit einem Farbwiedergabeindex  $> 90$  und einer Effizienz von bis zu 159 lm/W erfüllt p.bright nicht nur höchste Qualitätsstandards, sondern auch die Förderkriterien von  $> 120$  lm/W. Das Ergebnis: eine energieeffiziente Lösung, die gleichzeitig optimale Lichtqualität garantiert.

## AESTHETICS AND QUALITY

**Direct and indirect light emission** | *The choice of direct or direct/indirect light emission offers diverse creative options, combining functionality and aesthetics perfectly.*

**Superior light quality and energy efficiency** | *With a CRI  $> 90$  and an efficiency of up to 159 lm/W, p.bright meets the highest quality standards and subsidy criteria ( $> 120$  lm/W). The result is an energy-efficient solution with optimal light quality.*



**P.BRIGHT  
PROJEKTE**



**INSPIRATION**

Produkt: p.bright







**INSPIRATION**

Produkt: p.bright, cosmo





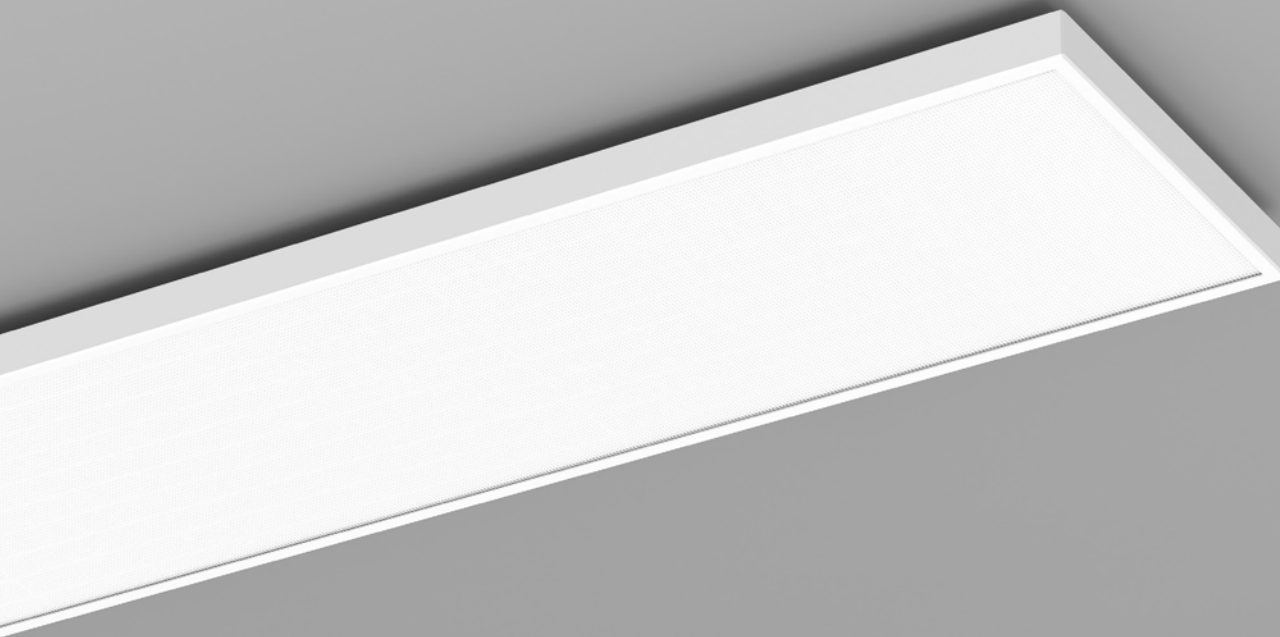







**1 SIZE**

microprism		microprism sensor	
578 mm	<b>057</b>	1158 mm	<b>115</b>
858 mm	<b>085</b>	1438 mm	<b>143</b>
1138 mm	<b>113</b>		
1418 mm	<b>141</b>		
1698 mm	<b>169</b>		
1978 mm	<b>197</b>		
2258 mm	<b>225</b>		
643 x 643 mm	<b>06L</b>		



**2 COLOUR**

	silver	<b>9006</b>
	white	<b>9016</b>
	black	<b>9005</b>
	RAL of your choice	









**3 DIRECT / INDIRECT**

	direct (DI)	<b>1</b>
	direct/indirect (DIID)	<b>2</b>

**4 LED**

	3000 K, CRI > 90	<b>930</b>
	4000 K, CRI > 90	<b>940</b>

**5 OUTPUT / CONTROL**

		non sensor	with sensor
		low output non-dim	<b>L1</b>
		low output DALI	<b>L3</b> <b>L7</b>
		medium output DALI	<b>M3</b> <b>M7</b>
		high output DALI	<b>H3</b> <b>H7</b>

P61A **1-2E345M**

P61A085 - 9006E1940H3M 858 mm, silver, direct, 4000 K, CRI > 90, high output DALI, microprism (order sample)

► Configure online on [KATALOG.PLANLICHT.COM](http://KATALOG.PLANLICHT.COM)

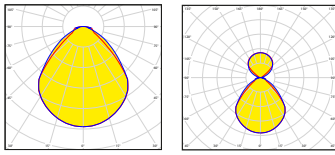

microprism direct

microprism direct/indirect

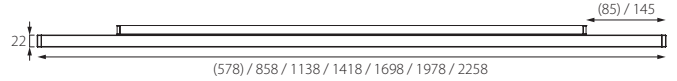
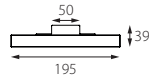

(578) / 858 / 1138 / 1418 / 1698 / 1978 / 2258

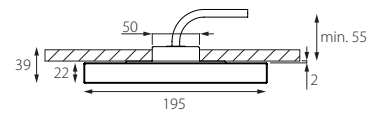
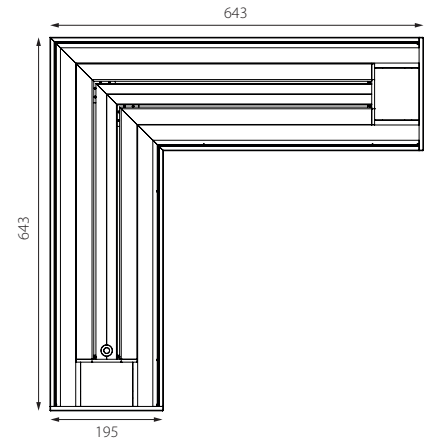
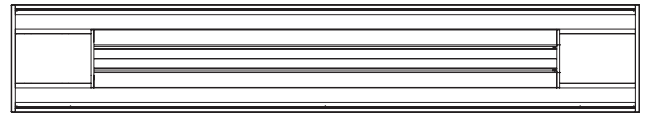

Halbeinbau-Montage möglich (ohne Zubehör möglich)  
Semi-recessed mounting possible (without additional accessories)  
Montage semi-encastée possible (sans accessoires possible)

**LUMINOUS FLUX (LM) / SYSTEM POWER (W)**

4000K microprism	low output CRI > 90		medium output CRI > 90		high output CRI > 90		Kg
	DI	DI/ID	DI	DI/ID	DI	DI/ID	
578mm	1191 lm / 9,3 W	1809 lm / 13,5 W	1637 lm / 11,8 W	2486 lm / 17,3 W	2076 lm / 15,1 W	3152 lm / 22,2 W	2,6 kg
858mm	1791 lm / 13,5 W	2715 lm / 19,4 W	2461 lm / 17,3 W	3731 lm / 25,5 W	3121 lm / 22,2 W	4731 lm / 32,8 W	3,7 kg
1138mm	2392 lm / 17,5 W	3621 lm / 24,1 W	3287 lm / 22,7 W	4976 lm / 32,9 W	4168 lm / 29,2 W	6310 lm / 42 W	4,9 kg
1418mm	2994 lm / 20,6 W	4528 lm / 29,6 W	4114 lm / 28 W	6222 lm / 40,6 W	5216 lm / 35,4 W	7889 lm / 52 W	6,1 kg
1698mm	3596 lm / 24,1 W	5434 lm / 34,9 W	4942 lm / 32,9 W	7468 lm / 48,5 W	6266 lm / 42 W	9469 lm / 62,3 W	7,3 kg
1978mm	4200 lm / 27,8 W	6342 lm / 40,2 W	5772 lm / 38,1 W	8715 lm / 56,4 W	7319 lm / 48,9 W	11051 lm / 72 W	8,5 kg
2258mm	4805 lm / 31,4 W	7249 lm / 45,5 W	6603 lm / 43,1 W	9962 lm / 62,9 W	8372 lm / 55,2 W	12631 lm / 81,8 W	9,7 kg
643x643mm	2693 lm / 19,7 W	4088 lm / 27,9 W	3700 lm / 25,5 W	5617 lm / 38,3 W	4692 lm / 32,8 W	7123 lm / 49,1 W	5,5 kg

**COMPARE LIGHT COLOUR 1418 MM, MICROPRISM**

4000 K, CRI > 90	4692 lm
3000 K, CRI > 90	4594 lm

**CUT OUT**

SIZE	WIDTH	LENGTH	↑ DEPTH
578 mm	53 mm	418 mm	55 mm
858 - 2258 mm	53 mm	SIZE - 280 mm	55 mm
643 x 643 mm	53 mm	563 x 563 mm	55 mm

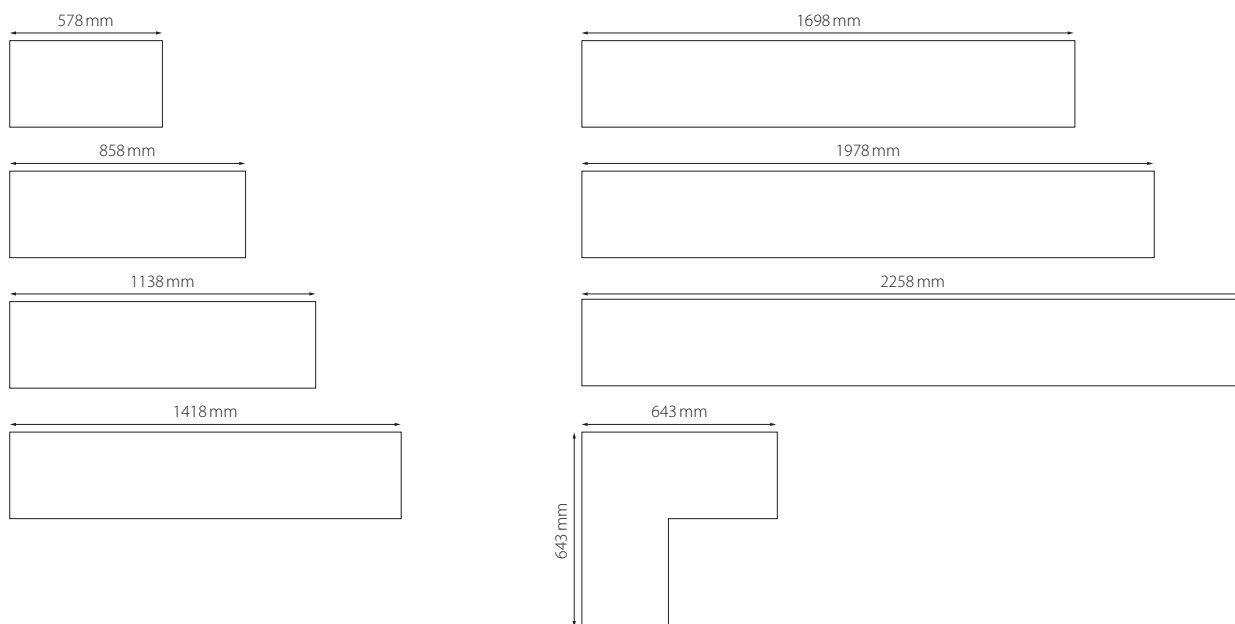





Down to UGR ≤ 16 | up to 159 lm/W | up to 5653 lm/m | IEC 62471: Blue light hazard: RG 0 | DALI switchDIM





**1 SIZE**

microprism		microprism sensor	
1138 mm	<b>113</b>	1158 mm	<b>115</b>
1418 mm	<b>141</b>	1438 mm	<b>143</b>
1698 mm	<b>169</b>		
1978 mm	<b>197</b>		
2258 mm	<b>225</b>		
643 x 643 mm	<b>06L</b>		



**2 COLOUR**

	silver	<b>9006</b>
	white	<b>9016</b>
	black	<b>9005</b>
	RAL of your choice	





**3 DIRECT / INDIRECT**

	direct (DI)	<b>1</b>
	direct/indirect (DIID)	<b>2</b>

**4 LED**

	3000 K, CRI > 90	<b>930</b>
	4000 K, CRI > 90	<b>940</b>

**5 OUTPUT / CONTROL**

		non sensor	with sensor
	low output non-dim	<b>L1</b>	
	low output DALI	<b>L3</b>	<b>L7</b>
	medium output DALI	<b>M3</b>	<b>M7</b>
	high output DALI	<b>H3</b>	<b>H7</b>

P61H**1**-**2**E**3****4****5**M

P61H113-9006E1940H3M 1138 mm, silver, direct, 4000 K, CRI > 90, high output DALI, microprism (order sample)

> Configure online on [KATALOG.PLANLICHT.COM](http://KATALOG.PLANLICHT.COM)



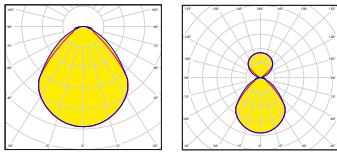

microprism direct

microprism direct/indirect

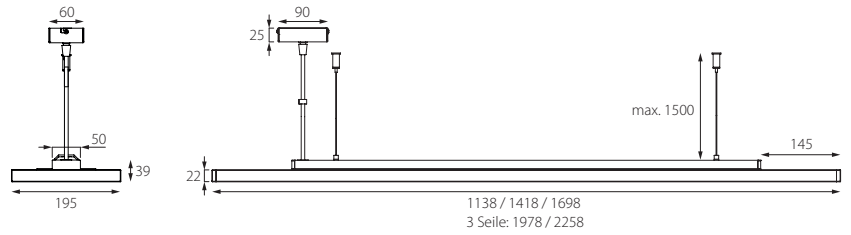

1138 / 1418 / 1698  
3 Seile: 1978 / 2258



**LUMINOUS FLUX (LM) / SYSTEM POWER (W)**

4000K microprism	low output CRI > 90		medium output CRI > 90		high output CRI > 90		KG
	DI	DI/ID	DI	DI/ID	DI	DI/ID	
1138 mm	2392 lm / 17,5 W	3621 lm / 24,1 W	3287 lm / 22,7 W	4976 lm / 32,9 W	4168 lm / 29,2 W	6310 lm / 42 W	5,3 kg
1418 mm	2994 lm / 20,6 W	4528 lm / 29,6 W	4114 lm / 28 W	6222 lm / 40,6 W	5216 lm / 35,4 W	7889 lm / 52 W	6,5 kg
1698 mm	3596 lm / 24,1 W	5434 lm / 34,9 W	4942 lm / 32,9 W	7468 lm / 48,5 W	6266 lm / 42 W	9469 lm / 62,3 W	7,7 kg
1978 mm	4200 lm / 27,8 W	6342 lm / 40,2 W	5772 lm / 38,1 W	8715 lm / 56,4 W	7319 lm / 48,9 W	11051 lm / 72 W	9,0 kg
2258 mm	4805 lm / 31,4 W	7249 lm / 45,5 W	6603 lm / 43,1 W	9962 lm / 62,9 W	8372 lm / 55,2 W	12631 lm / 81,8 W	10,2 kg
643 x 643 mm	2693 lm / 19,7 W	4088 lm / 27,9 W	3700 lm / 25,5 W	5617 lm / 38,3 W	4692 lm / 32,8 W	7123 lm / 49,1 W	6,0 kg

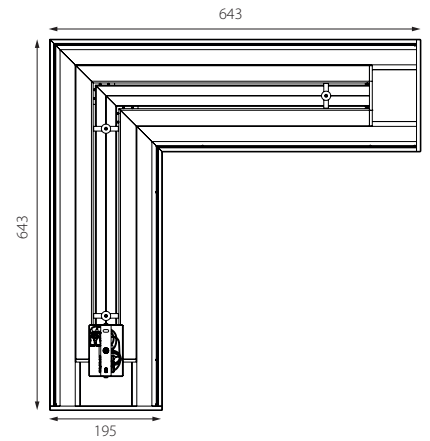

**COMPARE LIGHT COLOUR 1418 MM, MICROPRISM**

4000 K, CRI > 90	4692 lm
3000 K, CRI > 90	4594 lm

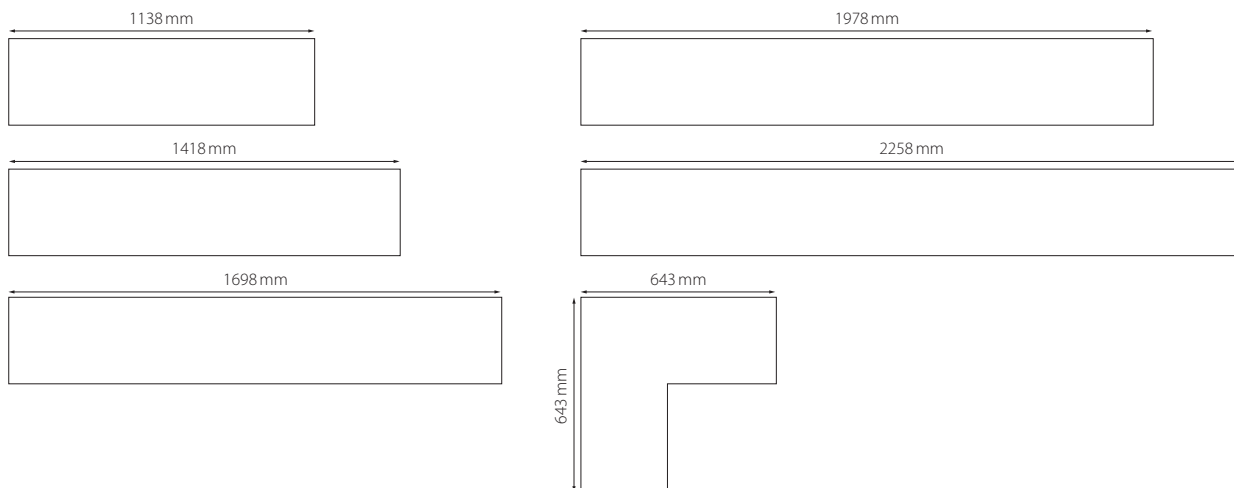



**1 SEGMENT LOCATION**

beginning | end  
middle

**RK**  
**ZK**

**2 SIZE**

RK (beginning   end)	ZK (middle)
574 mm <b>057</b>	570 mm <b>057</b>
854 mm <b>085</b>	850 mm <b>085</b>
1134 mm <b>113</b>	1130 mm <b>113</b>
1154 mm (with sensor) <b>115</b>	1150 mm (with sensor) <b>115</b>
1414 mm <b>141</b>	1410 mm <b>141</b>
1434 mm (with sensor) <b>143</b>	1430 mm (with sensor) <b>143</b>
1694 mm <b>169</b>	1690 mm <b>169</b>
1974 mm <b>197</b>	1970 mm <b>197</b>
2254 mm <b>225</b>	2250 mm <b>225</b>
643 x 643 mm <b>06L</b>	639 x 639 mm <b>06L</b>

**3 COLOUR**

	silver	<b>9006</b>
	white	<b>9016</b>
	black	<b>9005</b>
	RAL of your choice	

**4 DIRECT / INDIRECT**

direct (DI)  
 direct/indirect (DIID)

**1**  
**2**

**5 LED**

	3000 K, CRI > 90	<b>930</b>
	4000 K, CRI > 90	<b>940</b>

**6 OUTPUT / CONTROL**

	non sensor	with sensor
	low output non-dim <b>L1</b>	
	low output DALI <b>L3</b>	<b>L7</b>
	medium output DALI <b>M3</b>	<b>M7</b>
	high output DALI <b>H3</b>	<b>H7</b>

P61 **1 2 3 E 4 5 6 M**

P61RK085-9016E1940H3M Beginning | end segment 854 mm, white, direct, 4000 K, CRI > 90, high output DALI, microprism (order sample)

➤ [Configure online on KATALOG.PLANLICHT.COM](https://www.katalog.planlicht.com)

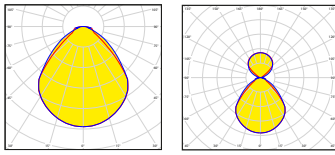

microprism direct

microprism direct/indirect

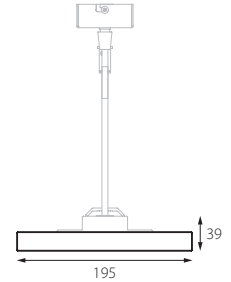
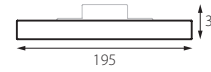
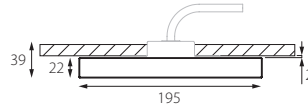

**CUT OUT**

SIZE	WIDTH	LENGTH	↑ DEPTH
all lengths	53 mm	SIZE-160 mm	55 mm

**LUMINOUS FLUX (LM) / SYSTEM POWER (W)**

4000K microprism	low output CRI > 90		medium output CRI > 90		high output CRI > 90		
	DI	DI/ID	DI	DI/ID	DI	DI/ID	
574 570mm	1191 lm / 9,3 W	1809 lm / 13,5 W	1637 lm / 11,8 W	2486 lm / 17,3 W	2076 lm / 15,1 W	3152 lm / 22,2 W	2,1 kg
854 850mm	1791 lm / 13,5 W	2715 lm / 19,4 W	2461 lm / 17,3 W	3731 lm / 25,5 W	3121 lm / 22,2 W	4731 lm / 32,8 W	3,2 kg
1134 1130mm	2392 lm / 17,5 W	3621 lm / 24,1 W	3287 lm / 22,7 W	4976 lm / 32,9 W	4168 lm / 29,2 W	6310 lm / 42 W	4,4 kg
1414 1410mm	2994 lm / 20,6 W	4528 lm / 29,6 W	4114 lm / 28 W	6222 lm / 40,6 W	5216 lm / 35,4 W	7889 lm / 52 W	4,9 kg
1694 1690mm	3596 lm / 24,1 W	5434 lm / 34,9 W	4942 lm / 32,9 W	7468 lm / 48,5 W	6266 lm / 42 W	9469 lm / 62,3 W	5,9 kg
1974 1970mm	4200 lm / 27,8 W	6342 lm / 40,2 W	5772 lm / 38,1 W	8715 lm / 56,4 W	7319 lm / 48,9 W	11051 lm / 72 W	6,7 kg
2254 2250mm	4805 lm / 31,4 W	7249 lm / 45,5 W	6603 lm / 43,1 W	9962 lm / 62,9 W	8372 lm / 55,2 W	12631 lm / 81,8 W	8,5 kg
643×643  639×639mm	2693 lm / 19,7 W	4088 lm / 27,9 W	3700 lm / 25,5 W	5617 lm / 38,3 W	4692 lm / 32,8 W	7123 lm / 49,1 W	4,2 kg

**COMPARE LIGHT COLOUR 1418 MM, MICROPRISM**

4000 K, CRI > 90	4692 lm
3000 K, CRI > 90	4594 lm

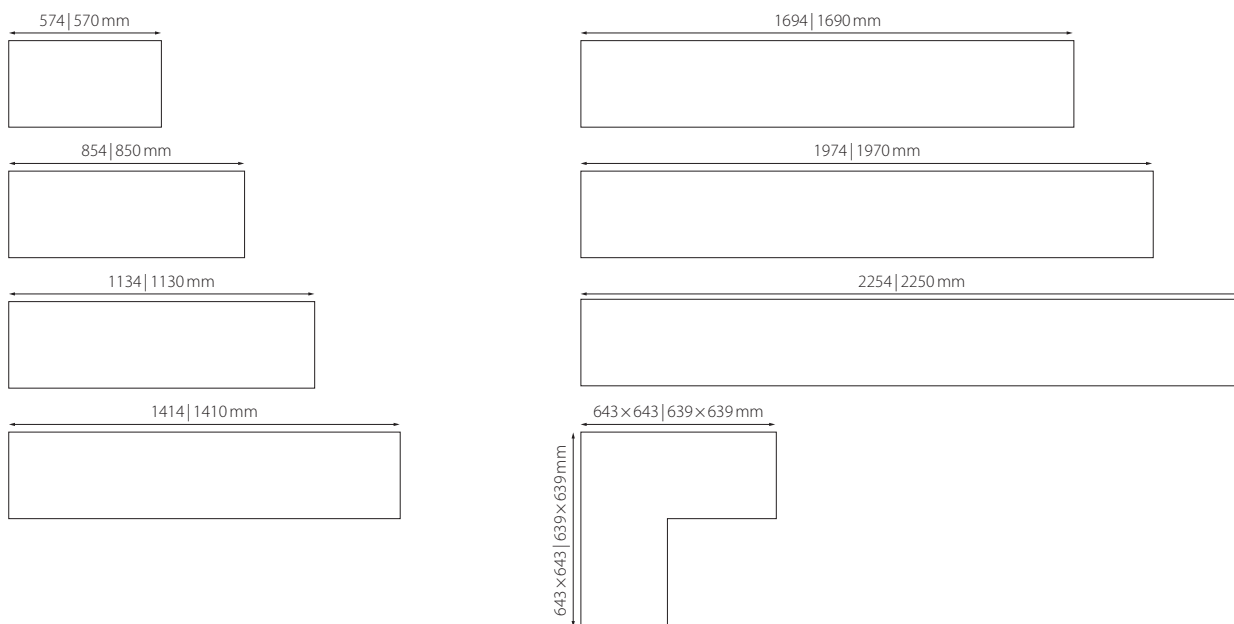



Down to UGR ≤ 16 | up to 159 lm/W | up to 5653 lm/m | IEC 62471: Blue light hazard: RG 0 | DALI switchDIM

## 01 MOUNTING PROFILE

-  P61-PRO1-9006
-  P61-PRO1-9016
-  P61-PRO1-9005

## 02 END CAP MOUNTING PROFILE

-  P61-PRO1-END-9006
-  P61-PRO1-END-9016
-  P61-PRO1-END-9005

## 03 BLANK COVER DIRECT

-  P61-PRO-BLI-9006
-  P61-PRO-BLI-9016
-  P61-PRO-BLI-9005

## 04 FEED-TROUGH WIRING FOR BLANK COVER

P61-DV-PRO-BLI

## 05 ILD SENSOR IN BLANK COVER

P61-PRO-SENSOR

## 06 BRIDGING FOR LIGHT SEGMENTS

P61-DV-LK

## 07 LINE CONNECTOR MOUNTING PROFILE

P61-PRO-LIN

## 08 BEGINN/END SEGMENT

p. 16/17

## 09 MIDDLE SEGMENT

p. 16/17

## 10 90° MIDDLE SEGMENT

p. 16/17

## 11 SEGMENT WITH SENSOR

p. 16/17

## 12 MITRE CUT + CROSS CONNECTOR 90°

P61-PRO-HOR-90

## 13 CONNECTION TERMINAL

P61-PRO-ANSS

5-pole

## 14 POWER SUPPLY

- P61-EIN-3 3 x 0,75 mm<sup>2</sup>
- P61-EIN-5 5 x 0,75 mm<sup>2</sup>
- P61-EIN-5-Q1,5 7 x 1,50 mm<sup>2</sup>

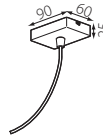

P61-EIN-5-DB (power supply with design canopy)  
1750mm

## 15 SUSPENSION CABLES

P61-PRO-SEI-150

1 per max. 1600mm | min. 2 Stück  
1 per max. 1600mm | min 2 pièces  
1 par max. 1600mm | min. 2 pièces

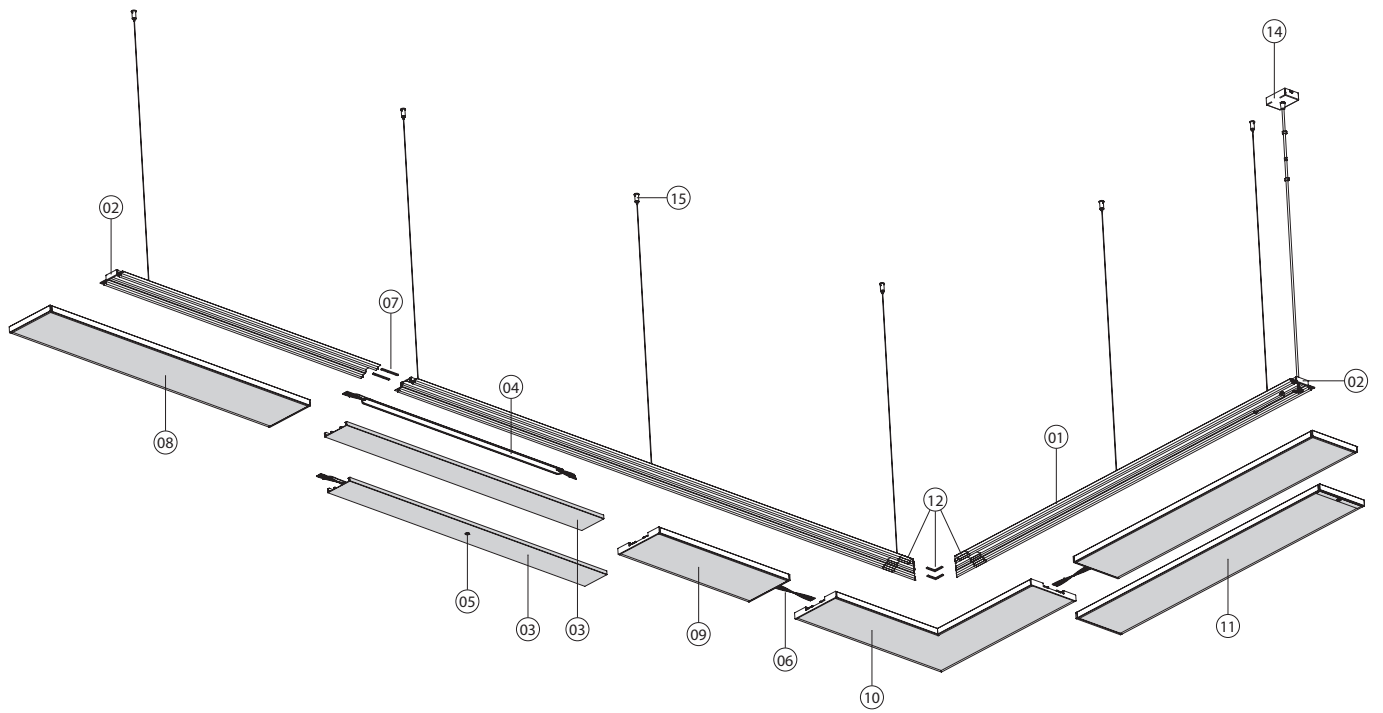
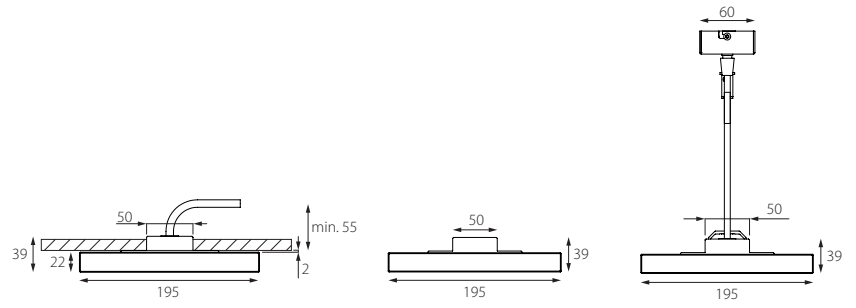

# FARBKARTEN | GEHÄUSE & KABEL

## COLOUR CHARTS | HOUSING & CABLES

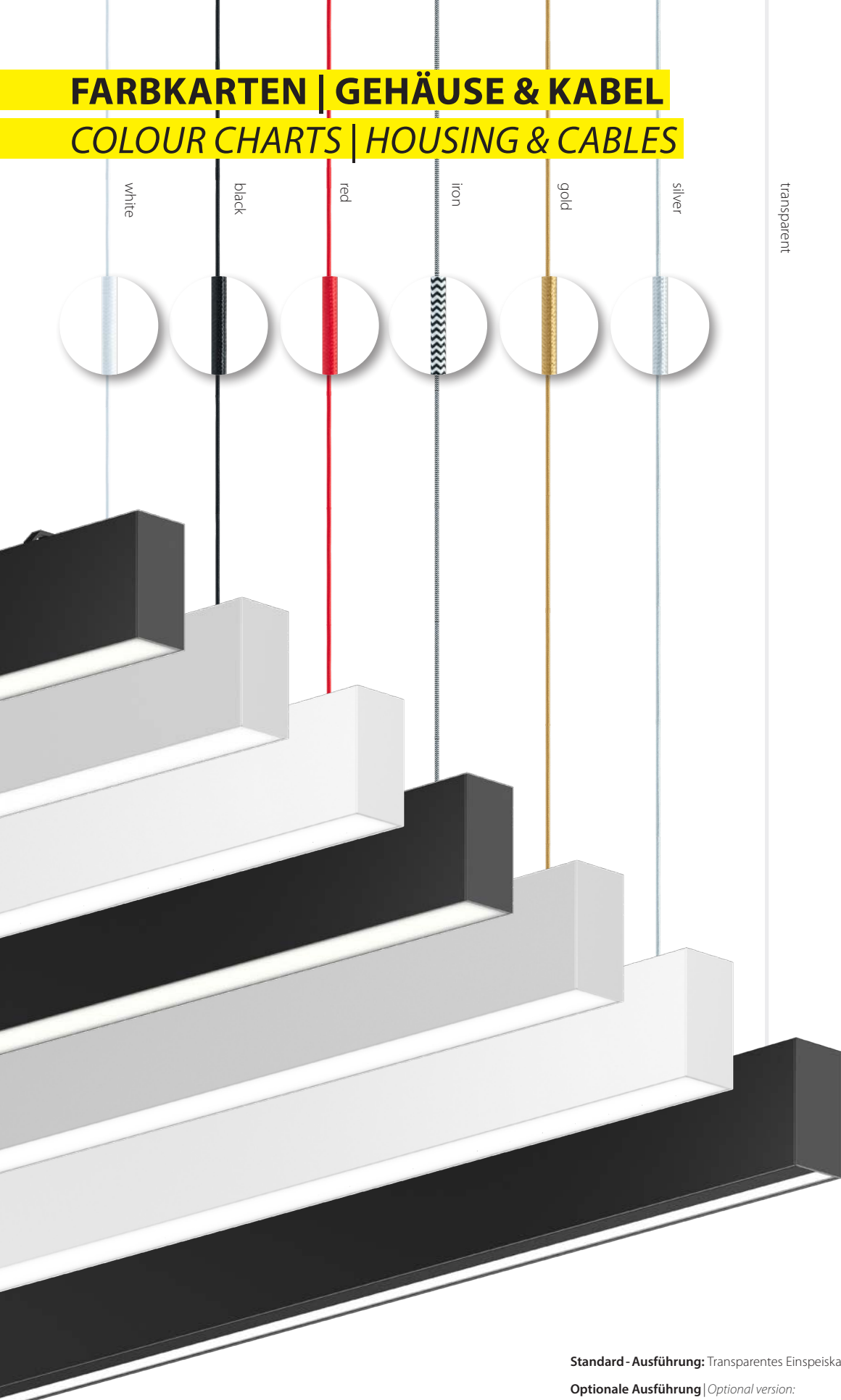

**Standard - Ausführung:** Transparentes Einspeiskabel | *Standard version: Transparent suspension cable*

**Optionale Ausführung** | *Optional version:*

**Einspeiskabel**  
*Suspension cable*

1750 mm  
5x0,75 mm<sup>2</sup>

▷ white	*-EIN-WHITE
▶ black	*-EIN-BLACK
◀ red	*-EIN-RED
▷ iron	*-EIN-IRON
▶ gold	*-EIN-GOLD
▷ silver	*-EIN-SILVER





# RAL NACH WAHL | OPTIONALE GEHÄUSEFARBEN

## RAL OF YOUR CHOICE | OPTIONAL HOUSING COLOURS



RAL 1001	RAL 1003	RAL 1004	RAL 1013	RAL 1014	RAL 1015	RAL 1016	RAL 1018	RAL 1019	RAL 1021
RAL 1023	RAL 1035	RAL 1036	RAL 2000	RAL 2001	RAL 2003	RAL 2008	RAL 2009	RAL 3000	RAL 3002
RAL 3003	RAL 3009	RAL 3011	RAL 3013	RAL 3016	RAL 3018	RAL 3020	RAL 3031	RAL 3032	RAL 3033
RAL 4005	RAL 4010	RAL 4011	RAL 4012	RAL 5002	RAL 5004	RAL 5010	RAL 5012	RAL 5013	RAL 5018
RAL 5023	RAL 5024	RAL 5025	RAL 5026	RAL 6013	RAL 6014	RAL 6017	RAL 6018	RAL 6019	RAL 6027
RAL 6034	RAL 7001	RAL 7004	RAL 7006	RAL 7011	RAL 7012	RAL 7013	RAL 7015	RAL 7016	RAL 7021
RAL 7022	RAL 7024	RAL 7030	RAL 7031	RAL 7032	RAL 7035	RAL 7037	RAL 7038	RAL 7039	RAL 7043
RAL 7044	RAL 7047	RAL 7048	RAL 8003	RAL 8011	RAL 8012	RAL 8016	RAL 8017	RAL 8019	RAL 8024
RAL 8024	RAL 8029	RAL 9001	RAL 9002	RAL 9011	RAL 9017	RAL 9022			
							Gunnery GREY	Capital COPPER	Glaring GOLD

## WICHTIGE HINWEISE

Dieser Katalog richtet sich ausschliesslich an gewerbliche Kunden. Die in diesem Katalog angegebenen Werte sind Bemessungswerte und unterliegen produktionsbedingten Toleranzen\*. Alle angeführten Angaben – insbesondere Grössen-, Material-, Farb- und technische Angaben – entsprechen dem Stand zum Zeitpunkt des Drucks und dienen ausschliesslich zur Information. Der Herausgeber haftet nicht für Satz- und Druckfehler sowie für Abweichungen der Produkte von Abbildungen und Angaben. PLANLICHT behält sich vor, jederzeit ohne Ankündigung Änderungen an Produkten vor zu nehmen. Es gelten die Allgemeinen Geschäftsbedingungen der planlicht GmbH & Co KG, die unter [WWW.PLANLICHT.COM/AGB-LANDING/](http://WWW.PLANLICHT.COM/AGB-LANDING/) eingesehen werden können.

Technische Kennzahlen, angeführte Werte und die Piktogramme betreffen zumindest einen aber nicht zwingend alle Artikel der jeweiligen Leuchtenfamilie, exakte Angaben je Artikel finden Sie im Online-Katalog bzw. in PLANLICHT-Verkaufsbelegen und Datenblättern.

WEEE-Reg.-Nr. DE 54728470

\* Leistung, Lichtstrom und Farbtemperatur unterliegen durch den Einsatz von elektronischen Bauteilen produktionsbedingten Toleranzen.  
Toleranzen Leistung und Lichtstrom: +/- 10%. Toleranz Farbtemperatur: +/- 150K.

## IMPORTANT REMARKS

*This catalogue is reserved for professionals only. The values published in this catalogue are rated values, which can slightly change for reasons related to the production process\*. The published data such as dimensions, materials, colours and technical data are valid at time of printing, and exclusively provided for informational purposes. The editor takes no responsibility for typographical and print errors, as well as for any differences in the products, pictures and data. PLANLICHT reserves the right to change the products at any time and without any notice. The Terms and Conditions of planlicht GmbH & Co KG (available on [WWW.PLANLICHT.COM/AGB-LANDING/](http://WWW.PLANLICHT.COM/AGB-LANDING/)) shall apply.*

*Key technical specifications, listed values as well as the pictogram bar relate to at least one but not necessarily all items of the respective luminaire family, exact details for each item can be found in the online web catalogue or in PLANLICHT sales documents and data sheets.*

*\* The power output, luminous flux and colour temperature can be slightly different due to specific electronic components used in the manufacturing process. The power output and luminous flux can differ by +/- 10%. The colour temperature can differ by +/- 150K.*

## REMARQUES IMPORTANTES

*Ce catalogue est exclusivement destiné aux professionnels. Les valeurs publiées dans ce catalogue sont des valeurs calculées, pouvant légèrement changer pour des raisons liées au processus de fabrication\*. Les données techniques et autres informations (dimensions, matériaux, couleurs...) sont celles applicables au moment de l'impression du catalogue, et uniquement fournies à titre informatif. L'éditeur décline toute responsabilité en cas d'erreur de frappe, d'impression et pour tout autre différence concernant les produits, images et données publiées. PLANLICHT se réserve le droit de modifier les produits à sa discrétion, à tout moment et sans préavis. Les conditions générales de vente de planlicht GmbH & Co KG applicables sont consultables sur [WWW.PLANLICHT.COM/AGB-LANDING/](http://WWW.PLANLICHT.COM/AGB-LANDING/).*

*Les caractéristiques techniques, les valeurs indiquées et la barre de pictogrammes concernent au moins un article de la famille de luminaires concernée, mais pas nécessairement tous. Vous trouverez des informations exactes par article dans le catalogue en ligne ou dans les documents de vente et les fiches techniques de PLANLICHT.*

*\* La puissance, le flux lumineux et la température de couleur peuvent légèrement différer en raison de l'utilisation de composants électroniques spécifiques dans le processus de production. La puissance et le flux lumineux peuvent différer de +/- 10%. La température de couleur peut différer de +/- 150K.*



Allgemeine Geschäfts- und Lieferbedingungen  
General Terms and Conditions  
Conditions générales de vente et de livraison



Webseite  
Website  
Site web



6134 Vomp, Austria, Au 25  
Tel. +43-5242-71608, Fax +43-5242-71283  
[info@planlicht.com](mailto:info@planlicht.com)  
[WWW.PLANLICHT.COM](http://WWW.PLANLICHT.COM)

## IMPRINT

**Publisher:** planlicht GmbH & Co. KG, Vomp  
**Creative Concept:** Katrin Atzinger  
**Graphic Design:** Beatrice Praxmarer, Christoph Höflinger  
**Print:** Kraler Druck, Vahrn (BZ)  
© 2025



[WWW.PLANLICHT.COM](http://WWW.PLANLICHT.COM)